

illumina®

# NovaSeq 6000

## Sequencing System Guide

ILLUMINA PROPRIETARY

Document # 1000000019358 v17

September 2022

**For Research Use Only. Not for use in diagnostic procedures.**

This document and its contents are proprietary to Illumina, Inc. and its affiliates ("Illumina"), and are intended solely for the contractual use of its customer in connection with the use of the product(s) described herein and for no other purpose. This document and its contents shall not be used or distributed for any other purpose and/or otherwise communicated, disclosed, or reproduced in any way whatsoever without the prior written consent of Illumina. Illumina does not convey any license under its patent, trademark, copyright, or common-law rights nor similar rights of any third parties by this document.

The instructions in this document must be strictly and explicitly followed by qualified and properly trained personnel in order to ensure the proper and safe use of the product(s) described herein. All of the contents of this document must be fully read and understood prior to using such product(s).

FAILURE TO COMPLETELY READ AND EXPLICITLY FOLLOW ALL OF THE INSTRUCTIONS CONTAINED HEREIN MAY RESULT IN DAMAGE TO THE PRODUCT(S), INJURY TO PERSONS, INCLUDING TO USERS OR OTHERS, AND DAMAGE TO OTHER PROPERTY, AND WILL VOID ANY WARRANTY APPLICABLE TO THE PRODUCT(S).

ILLUMINA DOES NOT ASSUME ANY LIABILITY ARISING OUT OF THE IMPROPER USE OF THE PRODUCT(S) DESCRIBED HEREIN (INCLUDING PARTS THEREOF OR SOFTWARE).

© 2022 Illumina, Inc. All rights reserved.

All trademarks are the property of Illumina, Inc. or their respective owners. For specific trademark information, see [www.illumina.com/company/legal.html](http://www.illumina.com/company/legal.html).

## Revision History

Document	Date	Description of Change
Material # 20023471 Document # 1000000019358 v17	September 2022	Added NovaSeq 6000Dx research mode considerations.
Material # 20023471 Document # 1000000019358 v16	June 2022	Removed incorrect cluster cartridge preparation instructions.
Material # 20023471 Document # 1000000019358 v15	May 2022	Added: <ul style="list-style-type: none"> <li>• Illumina Connected Analytics information.</li> <li>• The prevacuum check.</li> <li>• Clarification that DPX3 is compatible with v1.0 and 1.5 reagent kits.</li> </ul>
Material # 20023471 Document # 1000000019358 v14	September 2020	Updated available kit catalog numbers to reflect current v1.0 and v1.5 reagent kit offerings.
Material # 20023471 Document # 1000000019358 v13	July 2020	Added information in support of the NovaSeq 6000 Reagent Kit v1.5 and software v1.7, which allows for per lane metric breakdowns on certain run metrics data fields.

<b>Document</b>	<b>Date</b>	<b>Description of Change</b>
Material # 20023471 Document # 1000000019358 v12	February 2020	Moved denature and dilute information to new NovaSeq 6000 Denature and Dilute Guide (document # 1000000106351).
Material # 20023471 Document # 1000000019358 v11	February 2019	Updated Library Pool Plexity table for the Xp workflow.
Material # 20023471 Document # 1000000019358 v10	January 2019	Added SP flow cell information. Updated recommended library pool plexity tables for the Standard and Xp workflows.
Material # 20023471 Document # 1000000019358 v09	November 2018	Corrected link to NovaSeq 6000 support page. Corrected missing warning.
Material # 20020483 Document # 1000000019358 v08	September 2018	Added NovaSeq 6000 S4 Kit (200 cycles) information. Added user account information. Added single cell loading concentrations. Updated instructions for staggered start of runs. Updated BaseSpace sign in instructions. Updated pre-run check instructions. Added notes about requirement to confirm shutdown or restart. Added note about incomplete post-run wash. Clarified maintenance wash information. Clarified software update information.

Document	Date	Description of Change
Material # 20020483 Document # 1000000019358 v07	April 2018	Clarified usage of the library tube to mix reagents in the boost step before sequencing. Added a symbol descriptions table for symbols on the consumables or consumable packaging. Added information about the Illumina Proactive monitoring service in the Run Setup Modes section. Added information about the NovaSeq LIMS API. Updated software descriptions to NovaSeq Control Software v1.4.0 Updated typical number of reads passing filter for S2 flow cells. Updated recommended loading concentrations for the NovaSeq Xp workflow. Updated instructions for opening the flow cell packaging. Clarified procedure for loading libraries onto the flow cell. Added note about availability of the instrument for starting a maintenance wash. Added information about the staggered start countdown timer. Updated instructions on how to add or remove SRP rules.

Document	Date	Description of Change
Document # 1000000019358 v06	February 2018	<p>Added note in Flow Cell section to indicate software version 1.3.1 is required when using an S1 flow cell.</p> <p>Updated descriptions and Standard volume in table in <i>Library Loading Methods</i>.</p> <p>Added caution in <i>Reagent Kit Components</i>.</p> <p>Added 0.5 and 1.5 ml tubes, pipettes tips for 20, 200, 1000 µl pipettes to Consumables table. Added graduated cylinder to Equipment table.</p> <p>Added <i>Prepare the Flow Cell</i> section in Chapters 4 and 5, moved steps from Chapter 6 to these sections.</p> <p>Updated total volume for the S1 flow cell in Chapter 4.</p> <p>Added Recommended Library Pool Plexity table to <i>Create a Normalized Library Pool</i> in Chapter 4.</p> <p>Updated <i>Thaw SBS and Cluster Cartridges</i> steps in Chapters 4 and 5.</p> <p>Clarified thawing instructions in <i>Prepare Flow Cell</i>.</p> <p>Updated thawing information in <i>NovaSeq Xp Recommended Loading Concentrations</i>.</p> <p>Updated Recommended Library Pool Plexity table in <i>Create a Normalized Library Pool</i> in Chapter 5.</p> <p>Added sentence specifying that flow cell must be used within 12 hours after removing it from packaging in <i>NovaSeq Xp Workflow Summary</i> and <i>Prepare Flow Cell</i>.</p>

Document	Date	Description of Change
<p>Document # 1000000019358 v05</p>	<p>December 2017</p>	<p>Added clarification about empty library tube for Xp in the Sequencing Workflow diagram.</p> <p>In Denature Library and Option PhiX Control for the Standard workflow, updated Tris-HCl volumes in table for step 5.</p> <p>In Prepare the ExAmp Master Mix for the NovaSeq Xp workflow, added note after step 4 to indicate that vortexing is required for best results.</p> <p>In Load Libraries onto the Flow Cell for the NovaSeq Xp workflow, added reminder after step 3 to load samples slowly.</p>
<p>Material # 20023471 Document # 1000000019358 v04</p>	<p>October 2017</p>	<p>Added individual lane loading to the list of instrument features.</p> <p>Consumables - added the NovaSeq Xp 2-Lane Kit and NovaSeq Xp 4-Lane kit. Added NovaSeq Xp 2-Lane Manifold Pack and NovaSeq 4-Lane Manifold Pack.</p> <p>Equipment - added the NovaSeq Xp Flow Cell Dock and P200 Pipette for NovaSeq Xp Workflow.</p> <p>Added a Preparing Consumables chapter for the NovaSeq Xp workflow</p> <p>Moved Empty Used Reagent Bottles from the Sequencing chapter to the beginning of the NovaSeq Standard Workflow and NovaSeq Xp Workflow chapters.</p> <p>Updated Pooled Library Concentration table and Recommended Loading Concentration table for the Standard workflow.</p>

Document	Date	Description of Change
Material # 20020483 Document # 1000000019358 v03	September 2017	<p>Updated software descriptions to NovaSeq Control Software v1.2, which includes support for the S1 and S4 flow cells.</p> <p>Added disk space requirements for a dual flow cell run for S1 and S4 flow cells.</p> <p>Specified the naming requirement for certain *.json files.</p> <p>Reorganized kit overview information in a <i>Kits and Accessories</i> chapter. This chapter covers configurations, components, and compatibility labeling for the reagent and library loading kits.</p> <p>Added the NovaSeq 6000 Reagent Kit to the user-supplied consumables.</p> <p>Updated pool and denature library instructions to include information for S1 and S4 flow cells.</p> <p>Updated the instructions for thawing reagent cartridges to require a two-hour water bath for S1 and S2, and a four-hour water bath for S4.</p> <p>Updated descriptions of the library tube, reagent cartridges, and flow cells to include S4 components.</p> <p>Added section on automatic software updates in the Maintenance chapter.</p> <p>Replaced the reference to <i>Reducing Whole-Genome Data Storage Footprint (Pub. No. 970-2012-013)</i> with <i>NovaSeq Series and HiSeq X Ten Data Quality Comparison (Pub.No.770-2017-010)</i>.</p> <p>Added note to step 3 in <i>Enter Run Parameters</i> in Chapter 6.</p> <p>Updated <i>Flow Cell Tiles</i> section to include S1 and S4 tile information.</p>



Document	Date	Description of Change
Material # 20018871 Document # 1000000019358 v02	April 2017	Added the following information: <ul style="list-style-type: none"> <li>• Illumina-supplied consumables required for a run.</li> <li>• Storage conditions of reagent kit components.</li> <li>• Recommendations for library loading concentration.</li> <li>• NaOH dilution for two flow cells.</li> <li>• Step to bring the flow cell to room temperature before loading.</li> <li>• Glove-changing step after emptying the used reagent bottles.</li> <li>• Configuration of LIMS output for third-party LIMS systems.</li> <li>• Naming convention for sample sheets.</li> <li>• Process Management icons and troubleshooting.</li> <li>• Appendix containing Windows security features and configuration instructions.</li> <li>• Contact information for technical assistance.</li> </ul> Increased reagent cartridge thaw time to 4 hours. Updated PhiX spike-in instructions to change 1% PhiX spike-in volume to 0.9 µl and use 10 mM Tris-HCl, pH 8.5 to dilute 10 nM PhiX. Updated instructions to clean the flow cell and flow cell stage only when particulate is visible. Updated maintenance wash frequency to every 14 days. Reorganized and consolidated consumable preparation instructions to improve continuity. Renamed the French doors to the liquid compartment doors.
Material # 20018406 Document # 1000000019358 v01	March 2017	Corrected the name of a column on the Process Management screen to Sequencing.

<b>Document</b>	<b>Date</b>	<b>Description of Change</b>
Material # 20015871 Document # 1000000019358 v00	February 2017	Initial release.

# Table of Contents

<b>Overview</b> .....	<b>1</b>
Introduction .....	1
Sequencing Overview .....	2
Sequencing Workflow .....	4
Instrument Components .....	6
<b>Kits and Accessories</b> .....	<b>12</b>
Kits Overview .....	12
Reagent Kit Components .....	13
NovaSeq Xp Kit Components .....	17
NovaSeq Xp Flow Cell Dock .....	18
User-Supplied Consumables and Equipment .....	19
Symbol Descriptions .....	23
<b>System Configuration</b> .....	<b>25</b>
Start the Instrument .....	25
Configure Settings .....	27
<b>Standard Workflow: Preparing Consumables</b> .....	<b>34</b>
Best Practices .....	34
Thaw SBS and Cluster Cartridges .....	34
Empty Used Reagent Bottles .....	35
Prepare Flow Cell .....	36
Pool and Denature Libraries for Sequencing .....	37
<b>NovaSeq Xp Workflow: Preparing Consumables</b> .....	<b>38</b>
NovaSeq Xp Workflow Summary .....	38
Methods .....	39
Thaw SBS and Cluster Cartridges .....	39
Empty Used Reagent Bottles .....	40
Prepare Flow Cell and Dock .....	42
Thaw ExAmp Reagents .....	42
Check Flow Cell Vacuum Pressure .....	42
Pool, Denature, and Load Libraries for Sequencing .....	43
<b>Sequencing</b> .....	<b>49</b>
Set Up a Sequencing Run .....	49
Monitor Run Progress .....	57

Staggered Start of Runs .....	58
Delete the Run .....	59
Detach Position #30 .....	59
Automatic Post-Run Wash .....	60
<b>Maintenance .....</b>	<b>61</b>
Preventive Maintenance .....	61
Perform a Maintenance Wash .....	61
Software Updates .....	65
<b>Troubleshooting .....</b>	<b>67</b>
Troubleshooting Resources .....	67
Troubleshooting Files .....	67
Pre-Run Check Errors .....	67
Process Management Troubleshooting .....	68
Run Failure Before Clustering .....	69
End a Run .....	70
Shut Down the Instrument .....	70
<b>Real-Time Analysis .....</b>	<b>72</b>
Real-Time Analysis Overview .....	72
Real-Time Analysis Workflow .....	74
<b>Output Folders and Files .....</b>	<b>78</b>
Sequencing Output Folder Structure .....	78
Sequencing Output Files .....	79
<b>Windows Security .....</b>	<b>80</b>
Password Requirements .....	80
Windows Firewall .....	80
Enhanced Mitigation Experience Toolkit .....	80
Software Restriction Policies .....	80
<b>NovaSeq 6000Dx Research Mode Considerations .....</b>	<b>84</b>
Introduction .....	84
NovaSeq 6000Dx Run Planning Options .....	84
NovaSeq 6000Dx Consumables Compatibility .....	84
NovaSeq 6000Dx Instrument Mode Indicators .....	85
<b>Index .....</b>	<b>86</b>

**Technical Assistance ..... 91**

# Overview

## Introduction

The Illumina® NovaSeq™ 6000 System packages scalable throughput and flexible sequencing technology into a production-scale platform with the efficiency and cost-effectiveness of a benchtop system.

## Features

- **Scalable sequencing**—The NovaSeq 6000 scales up to production-level sequencing with high-quality data for a broad range of applications.
- **Adjustable output**—The NovaSeq 6000 is a dual flow cell system with a broad output range. Sequence one flow cell, or sequence two flow cells with different read lengths simultaneously. Mix and match four types of flow cells and different read lengths.
- **Patterned flow cell**—A patterned flow cell generates tightly spaced clusters. The reduced spacing between nanowells increases cluster density and data output.
- **Onboard ExAmp mixing**—The NovaSeq 6000 mixes the ExAmp reagents with library, amplifies the library, and performs cluster generation for a streamlined sequencing workflow.
- **Individual lane loading**—The NovaSeq Xp flow cell dock allows preloading of libraries into individual lanes of the flow cell and reduces the library loading volume.
- **High-throughput line scanning**—The NovaSeq 6000 uses one camera with bidirectional scanning technology to quickly image the flow cell in two color channels simultaneously.
- **Real-Time Analysis (RTA)**—The NovaSeq 6000 uses an implementation of RTA called RTA3. This integrated software analyzes images and calls bases.
- **BaseSpace Sequence Hub integration**—The sequencing workflow is integrated with BaseSpace Sequence Hub, the Illumina genomics computing environment for data analysis, storage, and collaboration. As the run progresses, output files are streamed to the environment in real time.
- **BaseSpace Clarity LIMS ready**—Improve operational efficiency with end-to-end tracking of samples and reagents, automated workflows, and integrated instrument operation.
- **Illumina Connected Analytics Integration**—NovaSeq Control Software v1.8 and later is integrated with Illumina Connected Analytics, Illumina's genomics cloud environment for data analysis, storage, and collaboration. If ICA is enabled in your region, you can select your ICA domain during run set up. As the run progresses, output files are streamed to the environment in real time.

## Additional Resources

The [NovaSeq 6000 Sequencing System support pages](#) on the Illumina website provide additional system resources. These resources include software, training, compatible products, and the following documentation. Always check support pages for the latest versions.

Resource	Description
<a href="#">Custom Protocol Selector</a>	A wizard for generating customized end-to-end documentation that is tailored to the library prep method, run parameters, and analysis method used for the sequencing run.
<a href="#">NovaSeq Series Safety and Compliance Guide (document # 1000000019357)</a>	Provides information about operational safety considerations, compliance statements, and instrument labeling.
<a href="#">RFID Reader Compliance Guide (document # 1000000002699)</a>	Provides information about the RFID reader in the instrument, including compliance certifications and safety considerations.
<a href="#">NovaSeq Series Custom Primers Guide (document # 1000000022266)</a>	Provides information about replacing Illumina sequencing primers with custom sequencing primers.
<a href="#">NovaSeq 6000 System Guide (document # 1000000019358)</a>	Provides an overview of instrument components, instructions for preparing sequencing consumables, instructions for operating the instrument, and maintenance and troubleshooting procedures.

## Sequencing Overview

### Cluster Generation

During cluster generation, single DNA molecules are bound to the surface of the flow cell and simultaneously amplified to form clusters. For the Standard workflow, the ExAmp master mix is mixed with the libraries onboard the instrument before cluster generation. For the NovaSeq Xp workflow, the ExAmp reagents and libraries are mixed and delivered to the flow cell outside of the instrument. Volumes vary by flow cell type and workflow.

## Sequencing

Clusters are imaged using bidirectional scanning and two-channel sequencing chemistry. The camera uses sensors that detect red and green light to image each swath and simultaneously generate red and green images of the whole swath. After imaging, base calling is performed for clusters within each tile based on the ratio of red to green signal for each cluster, which is based on location determined by the patterned flow cell. This process is repeated for each cycle of sequencing.

## Analysis

As the run progresses, the NovaSeq Control Software (NVCS) automatically transfers base call (\*.cbcl) files to the specified output folder location for data analysis.

Several analysis methods are available and depend on your application. For more information, visit the [BaseSpace Sequence Hub support page on the Illumina website](#).



## Sequencing Workflow



Thaw SBS and cluster reagent cartridges.

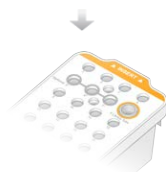

Pool and denature libraries. For the Standard workflow, add libraries to the library tube. For the NovaSeq Xp workflow, load ExAmp/library mix onto the flow cell.

For both workflows, load the library tube into the thawed cluster cartridge.

For more information, refer to the NovaSeq 6000 Denature and Dilute Guide (document # 1000000106351).



From the software interface, select **Sequence** and specify a dual or single flow cell run.



Unload consumables from the previous run and load new consumables for the current run.



Specify run parameters from the Run Setup screen. If BaseSpace Sequence Hub is configured, sign in from the Log In screen. After the pre-run checks are completed, the run starts automatically.

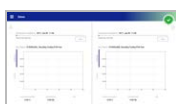

Monitor the run from the Sequence screen, BaseSpace Sequence Hub if run monitoring is enabled, or a network computer using Sequencing Analysis Viewer.

Data are transferred to the specified output folder.



An instrument wash begins automatically when sequencing is complete.

## Library Loading Methods

Libraries are loaded onto a NovaSeq 6000 flow cell using one of the following two methods, depending on the workflow selected. Setting up a sequencing run differs based on the workflow. Make sure that you always follow the instructions for your method. Refer to [Standard Workflow: Preparing](#)

[Consumables on page 34](#) and [NovaSeq Xp Workflow: Preparing Consumables on page 38](#).

Table 1 Library Loading Methods

Workflow	Library Pool Loading and ExAmp Mixing Method	Individual Lane Addressability and Data Analysis	Loading Volume* SP/S1–S2–S4 Modes (µl)
<b>Standard</b>	A single library pool is loaded into the library tube, mixed onboard in the library tube with the ExAmp reagents, and automatically delivered to the flow cell for clustering and sequencing. A boost step before sequencing uses reagents in the cluster cartridge and the library tube to create a conditioning mix that helps increase clustering efficiency.	A single library pool is distributed, and sequenced, across all lanes of the flow cell. Reads from all lanes are analyzed in aggregate.	150–225–465 µl (entire flow cell)
<b>NovaSeq Xp</b>	One or more libraries (the number corresponds to the number of flow cell lanes) are manually mixed with ExAmp reagents outside of the instrument and directly loaded into individual lanes of the flow cell using the NovaSeq Xp flow cell dock. The filled flow cell is then loaded onto the instrument for clustering and sequencing. A boost step before sequencing uses the empty library tube to mix reagents from the cluster cartridge to create a conditioning mix that helps increase clustering efficiency.	Each library is loaded into a separate lane of the flow cell, which is then sequenced. Different pools, aliquots of the same pool, or arbitrary combinations can be used. Reads from the different lanes are analyzed individually or in aggregate, accordingly.	27–33–45 µl (individual lane)

\*The NovaSeq Xp workflow requires a 25–50% lower concentration of denatured libraries compared to the Standard workflow.

## Instrument Components

The NovaSeq 6000 Sequencing System comprises a touch screen monitor, a status bar, a power button with adjacent USB ports, and three compartments.

Figure 1 External Components

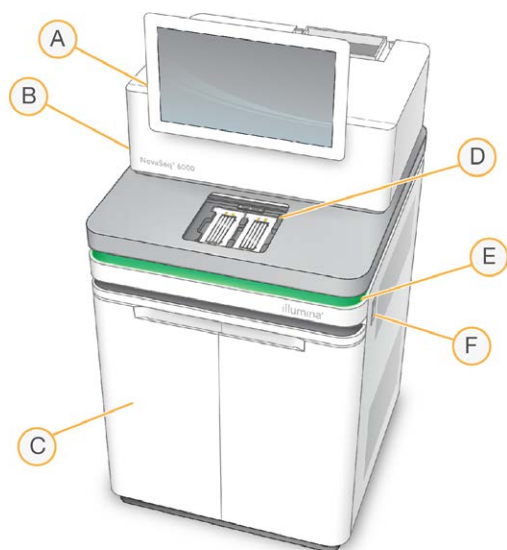

- A. **Touch screen monitor**—Displays the NVCS interface for system configuration and run setup and monitoring.
- B. **Optics compartment**—Contains the optical components that enable dual surface imaging of flow cells.
- C. **Liquids compartment**—Contains reagent and buffer cartridges, and bottles for used reagents.
- D. **Flow cell compartment**—Holds the flow cells.
- E. **Status bar**—Indicates flow cell status as ready to sequence (green), processing (blue), or needs attention (orange).
- F. **Power and USB ports**—Provides access to the power button and USB connections for peripheral components.

### Flow Cell Compartment

The flow cell compartment contains the flow cell stage, which holds flow cell A on the left and flow cell B on the right. Each side has four clamps that automatically position and secure the flow cell.

An optical alignment target mounted on the flow cell stage diagnoses and corrects optical problems. When prompted by the NVCS, the optical alignment target realigns the system and adjusts camera focus to improve sequencing results.

Figure 2 Flow Cell Stage

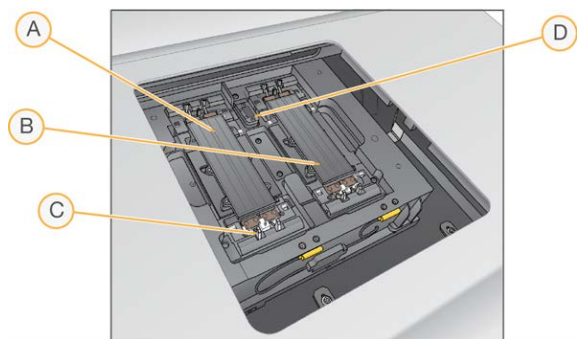

- A. Side A flow cell holder
- B. Side B flow cell holder
- C. Flow cell clamp (one of four per side)
- D. Optical alignment target

The software controls the opening and closing of the flow cell compartment door. The door opens automatically to load a flow cell for a run or maintenance wash. After loading, the software closes the compartment door, moves the flow cell into position, and engages the clamps and vacuum seal. Sensors verify the presence and compatibility of the flow cell.

## Liquids Compartment

Setting up a run requires accessing the liquids compartment to load reagents and buffer and empty used reagent bottles. Two doors enclose the liquids compartment, which is divided into two matching sides for flow cell A and flow cell B.

Figure 3 Liquids Compartment Components

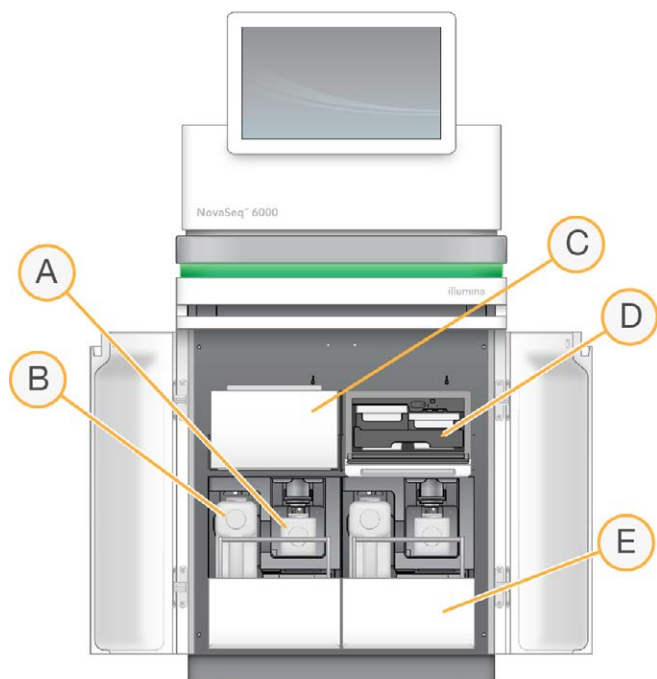

- A. **Small used reagent bottle**—Holds used reagents from the cluster cartridge, with a cap holder for easy cap storage.
- B. **Large used reagent bottle**—Holds used reagents from the SBS and buffer cartridges, with a cap holder for easy cap storage.
- C. **Reagent chiller**—Refrigerates the SBS and cluster cartridges.
- D. **Reagent chiller drawer**—Color-coded positions hold the SBS cartridge on the left (gray label) and the cluster cartridge on the right (orange label).
- E. **Buffer drawer**—Holds the large used reagent bottle on the left and the buffer cartridge on the right.

## Used Reagents

The fluidics system is designed to route cluster cartridge reagents, which are potentially hazardous, to the small used reagent bottle. Reagents from the SBS and buffer cartridges are routed to the large used reagent bottle. However, cross-contamination between used reagent streams can occur. Assume that both used reagent bottles contain potentially hazardous chemicals. The safety data sheet (SDS) provides detailed chemistry information.

**i** | If the system is configured to collect used reagents externally, the stream to the large used reagent bottle is routed externally. Cluster cartridge reagents always go to the small used reagent bottle.

## System Software

The instrument software suite includes integrated applications that perform sequencing runs, on-instrument analysis, and related functions.





- **NovaSeq Control Software (NVCS)**—Guides you through the steps to set up a sequencing run, controls instrument operations, and displays statistics as the run progresses. To demonstrate proper unloading and loading of consumables, NVCS plays instructional videos during run setup.
- **Real-Time Analysis (RTA)**—Performs image analysis and base calling during a run. NovaSeq 6000 uses RTA3, which incorporates architecture, security, and other feature enhancements to optimize performance. For more information, refer to [Real-Time Analysis on page 72](#).
- **Universal Copy Service (UCS)**—Copies output files from RTA3 and NVCS to the output folder throughout a run. If applicable, the service also transfers data to BaseSpace Sequence Hub. If the Universal Copy Service is interrupted during a run, the service makes multiple attempts to reconnect and automatically resume data transfer.

## Status Icons

A status icon on the NVCS interface indicates run status. A number on the icon indicates the number of conditions for a status.

When a run status changes, the icon blinks to alert you. Select the icon to view a description of the condition. Select **Acknowledge** to clear the message, and then **Close** to close the dialog box.

Table 2 NVCS Status Icons







Status Icon	Status Name	Description
	Status okay	System is normal.
	Processing	System is processing.
	Warning	A warning has occurred and attention is required. Warnings do not stop a run or require action before proceeding.
	Error	An error has occurred. Errors require action before proceeding with the run.

## Process Management

The Process Management screen provides access to the Compute Engine (CE) and hard drive (C:\). Use the screen to monitor run progress, delete runs, and otherwise manage disk space. Never delete files and folders directly from C:\.

Process Management displays available disk space, space used on CE and C:\, and the status of runs using disk space. Run Date and Name columns identify each run. Run Status, BaseSpace, and Network columns show the status of each process for a run.

Table 3 Process Management Status Icons

Process	Icon	Description
Run Status	 Running	The run is in progress.
	 Complete	The run has completed sequencing.
Network	 Copying	Files are being copied to the output folder on the network.
	 Complete	All files are copied to the output folder on the network.
	N/A	Not applicable because the run is not configured to upload to a network output folder or the upload status is unknown. To troubleshoot, refer to <a href="#">Process Management Troubleshooting on page 68</a> .
Cloud	 Uploading	Files are being uploaded to the selected cloud hosting option.
	 Complete	All files are uploaded to the selected cloud hosting option.
	N/A	Not applicable because the run is not configured to upload to the cloud or the upload status is unknown. To troubleshoot, refer to <a href="#">Process Management Troubleshooting on page 68</a> .

## Minimum Space Requirements

Before a flow cell run can begin, the minimum space requirements for CE and C:\ must be met.

**i** | For single flow cell runs, the minimum space requirements are half of those shown in the following table.

**Table 4** Minimum Space Requirements for CE and C:\ for Dual flow cell Runs

Flow cell	CE Space per cycle (Gb)	C:\ Space per flow cell pair (Gb)
SP	0.5	5
S1	1.35	20
S2	2.7	20
S4	4.3	40

To calculate the total space required in the CE for the run, multiply the 'CE minimum space requirement per cycle by the sum of the Read 1, Read 2, Index 1, and Index 2 length values (refer to [Enter Run Parameters on page 53](#)). For example, for a paired-end 150 cycle, dual flow cell S4 run with both indexes 8 bases long, the space required on the CE is 1.37 Tb.

For information on clearing disk space, refer to [Delete the Run on page 59](#).



# Kits and Accessories

## Kits Overview

Performing a run on the NovaSeq 6000 requires a NovaSeq 6000 Reagent Kit. The NovaSeq Xp workflow also requires a NovaSeq Xp Kit. These kits are available in the following configurations.

For a complete list of items needed for a run, refer to [User-Supplied Consumables and Equipment on page 19](#).

Table 5 Kit Configurations





Kit Name	v1.0 Reagents Illumina Catalog #	v1.5 Reagents Illumina Catalog #
NovaSeq 6000 S4 Reagent Kit (300 cycles) – 40 pack	20039236	N/A
NovaSeq 6000 S4 Reagent Kit (300 cycles) – 20 pack	20039234	N/A
NovaSeq 6000 S4 Reagent Kit (300 cycles) – 10 pack	20039233	N/A
NovaSeq 6000 S4 Reagent Kit (300 cycles)	20012866	20028312
NovaSeq 6000 S4 Reagent Kit (200 cycles)	20027466	20028313
NovaSeq 6000 S4 Reagent Kit (35 cycles)	N/A	20044417
NovaSeq 6000 S2 Reagent Kit (300 cycles)	20012860	20028314
NovaSeq 6000 S2 Reagent Kit (200 cycles)	20012861	20028315
NovaSeq 6000 S2 Reagent Kit (100 cycles)	20012862	20028316
NovaSeq 6000 S1 Reagent Kit (300 cycles)	20012863	20028317
NovaSeq 6000 S1 Reagent Kit (200 cycles)	20012864	20028318
NovaSeq 6000 S1 Reagent Kit (100 cycles)	20012865	20028319
NovaSeq 6000 SP Reagent Kit (500 cycles)	20029137	20028402
NovaSeq 6000 SP Reagent Kit (300 cycles)	20027465	20028400
NovaSeq 6000 SP Reagent Kit (200 cycles)	20040326	20040719
NovaSeq 6000 SP Reagent Kit (100 cycles)	20027464	20028401

## Compatibility Labeling

To identify compatible kit components, flow cells and cartridges are labeled with symbols that show the kit mode: **SP**, **S1**, **S2**, or **S4**. NovaSeq Xp manifolds support multiple modes and are labeled either 2-lane (for SP, S1, and S2 flow cells) or 4-lane (for S4 flow cells).

Components with different modes cannot be used in the same run. For example, do not pair S1 cartridges with an S2 flow cell.

Mixing v1.0 SBS/CPE cartridges and v1.5 cartridges is not permitted and will result in an error message.

Kit Mode	Marking on Label	Description
SP kit components		SP flow cell generates 650 to 800 million single reads passing filter, with output up to 250 Gb at 2 x 150 bp and output up to 400 Gb at 2 x 250 bp.
S1 kit components		S1 flow cell generates up to 1.6 billion single reads passing filter with output up to 500 Gb at 2 x 150 bp. The S1 kit provides fast sequencing of fewer samples for most high throughput applications.
S2 kit components		S2 flow cell generates up to 4.1 billion single reads passing filter with output up to 1250 Gb at 2 x 150 bp. It is a two lane version of the flow cell. The S2 flow cell provides fast sequencing for most high-throughput applications, with a greater number of reads than an S1 flow cell for more sequencing output.
S4 kit components		S4 flow cell generates up to 10 billion single reads passing filter with output up to 3000 Gb at 2 x 150 bp. It is a four lane version of the flow cell designed for maximum output. It enables cost-effective whole-genome sequencing across a range of species and depths of coverage.

The NovaSeq 6000 Sequencing System [product page](#) on the Illumina website provides detailed specifications for each mode.

## Reagent Kit Components

Each NovaSeq 6000 Reagent Kit contains the following components. Each component uses radio-frequency identification (RFID) for accurate consumable tracking and compatibility.

When you receive your kit, promptly store components at the indicated temperature to ensure proper performance.

Table 6 Kit Components

Quantity	Kit Component	Storage Temperature
1	Library tube	15°C to 30°C
1	Flow cell	2°C to 8°C
1	Buffer cartridge	15°C to 30°C
1	Cluster cartridge	-25°C to -15°C
1	SBS cartridge	-25°C to -15°C

**!** Avoid dropping cartridges. Injury may occur if dropped. Skin irritation may occur if reagents leak from cartridges. Inspect cartridges for cracks before use.

## Library Tube

The NovaSeq 6000 library tube is a 16 mm tube that fits into position #8 of the cluster cartridge. Position #8 is labeled **Library Tube** and circled in orange for easy identification. The tube has a threaded cap that allows storage of libraries when necessary. Make sure that the cap has been removed before loading into the cluster cartridge.

Figure 4 Library Tube



The library tube is used one of two ways, depending on workflow:

- **Standard**—Pooled and denatured libraries are added to the library tube, which is then loaded uncapped into the cluster cartridge. After the run begins, the instrument mixes the libraries with ExAmp reagents in the library tube, which are then transferred automatically to the flow cell.
- **NovaSeq Xp**—The empty, uncapped library tube is loaded into the cluster cartridge. During the run, reagents are mixed in the library tube before distribution to the flow cell.

## Flow Cell

The NovaSeq 6000 flow cell is a patterned flow cell encased in a cartridge. The flow cell is a glass-based substrate containing billions of nanowells in an ordered arrangement, which increases the number of output reads and sequencing data. Clusters are generated in the nanowells from which sequencing is then performed.

Each flow cell has multiple lanes for sequencing pooled libraries. The SP, S1, and S2 flow cells have two lanes each, and the S4 flow cell has four. Each lane is imaged in multiple swaths, and the software then divides the image of each swath into smaller portions called tiles. For more information, refer to [Flow Cell Tiles on page 73](#).

**i** | If you are using an S1 flow cell, make sure to use NVCS v1.3.1, or later. If you are using an SP flow cell, make sure to use NVCS v1.6 or later.

Figure 5 Flow Cells

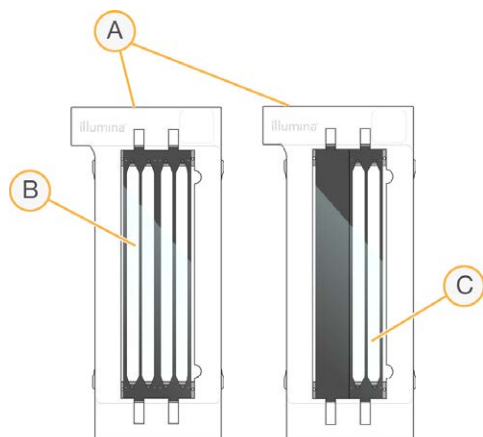

- A. Flow cell cartridge
- B. Four-lane flow cell (S4)
- C. Two-lane flow cell (SP, S1, and S2)

The underside of each flow cell has four gaskets. Libraries and reagents enter the flow cell lanes through the gaskets on the inlet end of the flow cell. Used reagents are expelled from the lanes through the gaskets at the outlet end.

**i** | Avoid touching the gaskets when handling the flow cell.

Figure 6 Inverted Flow Cell

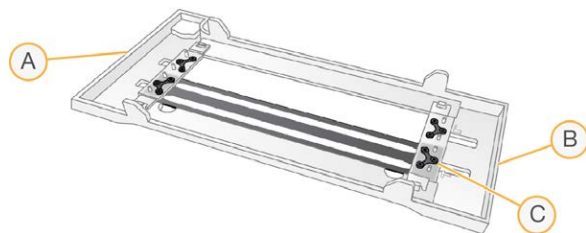

- A. Outlet end
- B. Inlet end
- C. Gasket (one of four)



## Buffer, Cluster, and SBS Cartridges

The NovaSeq 6000 buffer, cluster, and SBS cartridges have foil-seal reservoirs prefilled with reagents, buffers, and wash solution. One of each cartridge type is included with the reagent kit.

The cartridges load directly onto the instrument, and are color-coded and labeled to reduce loading errors. Guides in the reagent chiller and buffer drawers ensure proper orientation.

The label for a cartridge includes the supported modes, such as S1/S2 or SP/S1/S2. Cartridges can only be used for modes that are listed on the label.

Table 7 Reagent Cartridges

Cartridge	Description
NovaSeq 6000 buffer cartridge 	Prefilled with sequencing buffers and weighs up to 6.8 kg (15 lbs). A plastic handle facilitates carrying, loading, and unloading. Indentations in the top plate allow cartridges to be stacked.
NovaSeq 6000 cluster cartridge 	Prefilled with clustering, indexing, and paired-end reagents and wash solution. Includes a designated position for the library tube. Orange labeling distinguishes the cluster cartridge from the SBS cartridge.
NovaSeq 6000 SBS cartridge 	Prefilled with sequencing reagents at volumes specific to the number of cycles the kit supports (500, 300, 200, 100, or 35). Each of the three reagent positions has an adjacent position reserved for the automatic post-run wash. Gray labeling distinguishes the SBS cartridge from the cluster cartridge.

## Cluster Cartridge Reservoirs

### Removable Reservoir

A denaturation reagent in position #30 contains formamide, which is an organic amide and reproductive toxin. To facilitate safe disposal of any unused reagent after the sequencing run, this reservoir is removable.

**i** | Do not stack the SBS cartridge on top of the cluster cartridge, which can disengage position #30.

## Reserved Reservoirs

Three reservoirs are reserved for custom primers and an empty position is reserved for the library tube. For sample traceability, the library tube is loaded into the cluster cartridge during run setup and remains with the cartridge through the end of the run.

Figure 7 Numbered Reservoirs

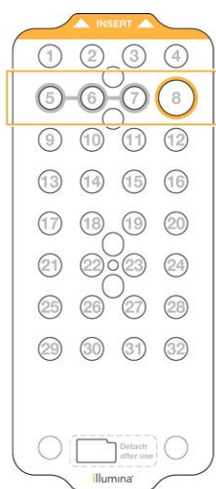

Position	Reserved For
5, 6, and 7	Optional custom primers
8	Library tube

For more information on custom primers, refer to the *NovaSeq Series Custom Primers Guide* (document # 1000000022266).

## NovaSeq Xp Kit Components

Each NovaSeq Xp Kit is single-use and contains the following components. When you receive your kit, promptly store components at the indicated temperature to ensure proper performance.

**i** | The DPX1 and DPX2 consumables may be labeled as JPX1 and JPX2. Either are compatible with v1.0 or v1.5 reagent kits. DPX3 is also compatible with v1.0 and v1.5 reagent kits.

Table 8 NovaSeq Xp Kit Components

Quantity	Kit Component	Storage Temperature
1	DPX1/JPX1	-25°C to -15°C
1	DPX2/JPX2	-25°C to -15°C
1	DPX3	-25°C to -15°C
1	NovaSeq Xp Manifold	Leave with the kit, or store at room temperature.

## Xp Kit Reagents

DPX1/JPX1, DPX2/JPX2, and DPX3 are ExAmp reagents provided in individual tubes for the NovaSeq Xp workflow. Combining these reagents creates the ExAmp master mix that is mixed with library pools before loading onto the flow cell.

## NovaSeq Xp Manifold

The NovaSeq Xp manifold is placed onto the NovaSeq Xp flow cell dock to enable direct loading of the library pools into the individual flow cell lanes. Arms on either side of the NovaSeq Xp manifold are designed for easy placement on the dock.

NovaSeq Xp manifolds are provided in two-well and four-well configurations to match the two-lane and four-lane flow cells. Each well corresponds to a flow cell lane. Because the flow cell is loaded into the NovaSeq Xp flow cell dock upside-down, wells are numbered right to left to match the lane numbering of an inverted flow cell.

Figure 8 NovaSeq Xp Manifolds With Numbered Wells

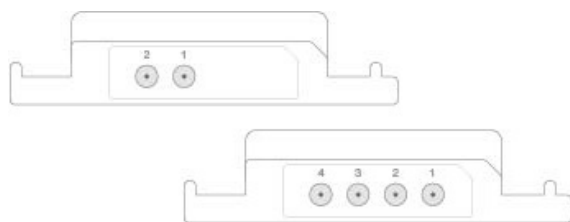

## NovaSeq Xp Flow Cell Dock

The NovaSeq Xp flow cell dock is a reusable accessory for loading libraries directly onto a flow cell. The flow cell is inverted and loaded into the dock, and the NovaSeq Xp manifold is fitted over the flow cell.

Two overhangs (under the bracket) and two springs guide flow cell insertion and ensure proper orientation. Cutouts hold the NovaSeq Xp manifold arms in the proper orientation, and evenly seated. A magnetic clamp rotates 180° to secure the NovaSeq Xp manifold over the flow cell.

Figure 9 NovaSeq Xp Flow Cell Dock

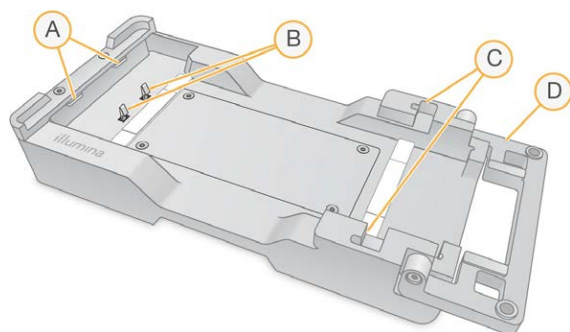

- A. Overhangs (under the bracket) to guide loading
- B. Springs to align the flow cell
- C. Cutouts to hold the NovaSeq Xp manifold arms
- D. Clamp to secure the flow cell and NovaSeq Xp manifold

## User-Supplied Consumables and Equipment

The following user-supplied consumables and equipment are used for consumable preparation, sequencing, and system maintenance.

### Consumables

Consumable	Supplier	Purpose
1 N NaOH	General lab supplier	Diluting to 0.2 N for denaturing libraries.
Centrifuge bottle, 500 ml	General lab supplier	Diluting Tween 20 for a maintenance wash.
Centrifuge tube, 30 ml	General lab supplier	Diluting NaOCl for a maintenance wash.
Disposable gloves, powder-free	General lab supplier	General purpose.
Isopropyl alcohol wipes, 70% or Ethanol alcohol wipes, 70%	VWR, catalog # 95041-714, or equivalent General lab supplier	Cleaning components before a run and general purpose.
Lab tissue, low-lint	VWR, catalog # 21905-026, or equivalent	Drying the flow cell stage and general purpose.
Microcentrifuge tube, 1.5 ml	VWR, catalog # 20170-038, or equivalent	Combining volumes when diluting NaOH and library.



Consumable	Supplier	Purpose
Reagent grade NaOCl, 5%	Sigma-Aldrich, catalog # 239305	Performing a maintenance wash.
NovaSeq 6000 Reagent Kit	Illumina, refer to <a href="#">Kits Overview on page 12</a>	Performing a sequencing run.
Pipette tips, 20 µl	General lab supplier	Pipetting for diluting and loading libraries.
Pipette tips, 200 µl	General lab supplier	Pipetting for diluting and loading libraries.
Pipette tips, 1000 µl	General lab supplier	Pipetting for diluting and loading libraries.
Reagent or spectrophotometric-grade isopropyl alcohol (99%), 100 ml bottle	General lab supplier	Cleaning optics components periodically and support the objective cleaning cartridge.
Tris-HCL, pH 7.0	General lab supplier	Neutralizing denatured libraries.
Tween 20	Sigma-Aldrich, catalog # P7949	Performing a maintenance wash.
Water, laboratory-grade	General lab supplier	Diluting NaOH for denaturing libraries. Diluting Tween 20 and sodium hypochlorite for a maintenance wash.
[NovaSeq Xp workflow] One of the following kits: <ul style="list-style-type: none"> <li>NovaSeq Xp 2-Lane Kit</li> <li>NovaSeq Xp 4-Lane Kit</li> </ul>	Illumina: <ul style="list-style-type: none"> <li>Catalog # 20021664</li> <li>Catalog # 20021665</li> </ul>	Manually loading libraries onto a flow cell: <ul style="list-style-type: none"> <li>Two-lane kit for SP, S1, and S2 flow cells</li> <li>Four-lane kit for S4 flow cells</li> </ul>

Consumable	Supplier	Purpose
[NovaSeq Xp workflow] One of the following kits: <ul style="list-style-type: none"> <li>NovaSeq Xp 2-Lane Kit v1.5</li> <li>NovaSeq Xp 4-Lane Kit v1.5</li> </ul>	Illumina: <ul style="list-style-type: none"> <li>Catalog # 20043130</li> <li>Catalog # 20043131</li> </ul>	Manually loading libraries onto a flow cell: <ul style="list-style-type: none"> <li>Two-lane kit for SP, S1, and S2 flow cells</li> <li>Four-lane kit for S4 flow cells</li> </ul>
[NovaSeq Xp workflow] 0.5 ml and 1.7 ml tubes	General lab supplier	Required for ExAmp mixing.
[NovaSeq Xp workflow] [Optional] One of the following manifold packs: <ul style="list-style-type: none"> <li>NovaSeq Xp 2-Lane Manifold Pack</li> <li>NovaSeq Xp 4-Lane Manifold Pack</li> </ul>	Illumina: <ul style="list-style-type: none"> <li>Catalog # 20021666</li> <li>Catalog # 20021667</li> </ul>	Spare NovaSeq Xp manifolds for manually loading libraries onto a flow cell.
[Optional] PhiX Control v3	Illumina, catalog # FC-110-3001	Spiking in PhiX control.

## Consumables in Illumina Kits

One NovaSeq 6000 Reagent Kit is needed to sequence one flow cell. Each kit is composed of multiple consumables, which are listed in the following table. For a dual flow cell run, use two kits.

Table 9 Consumables in a NovaSeq 6000 Reagent Kit

Consumable (One of Each)	Purpose
Buffer cartridge	Provides sequencing buffers for the run.
Cluster cartridge	Provides clustering, indexing, and paired-end reagents for the run.
Flow cell	The clustering and sequencing reaction happens on the flow cell.
SBS cartridge	Provides sequencing reagents for the run.
Library tube	Empty tube that is used to hold pooled and denatured customer-supplied libraries or to prepare the conditioning mix to boost clustering efficiency for sequencing.

If you are following the NovaSeq Xp workflow to load libraries directly onto the flow cell, supplement each reagent kit with one NovaSeq Xp Kit. Each NovaSeq Xp kit is composed of the following consumables.

**i** | The DPX1 and DPX2 consumables may be labeled as JPX1 and JPX2. Either are compatible with v1.0 or v1.5 reagent kits. DPX3 is also compatible with v1.0 and v1.5 reagent kits.

Table 10 Consumables in a NovaSeq Xp Kit

Consumable (One of Each)	Purpose
DPX1/JPX1	Preparing the ExAmp Master Mix.
DPX2/JPX2	
DPX3	
NovaSeq Xp manifold	Loading libraries onto the flow cell.

## Guidelines for Laboratory-Grade Water

Always use laboratory-grade water or deionized water to perform instrument procedures. Never use tap water. Use only the following grades of water or equivalents:

- Deionized water
- Illumina PW1
- 18 Megohms (MΩ) water
- Milli-Q water
- Super-Q water
- Molecular biology grade water









## Equipment

Item	Source
Freezer, -25°C to -15°C	General lab supplier
Graduated cylinder, 500 ml, sterile	General lab supplier
Ice bucket	General lab supplier
Pipette, 20 µl	General lab supplier
Pipette, 200 µl	General lab supplier
Pipette, 1000 µl	General lab supplier
Refrigerator, 2°C to 8°C	General lab supplier
Tub, water baths*	General lab supplier
[NovaSeq Xp workflow] NovaSeq Xp flow cell Dock	Illumina, catalog # 20021663

\* Use a tub that can accommodate two reagent cartridges and the appropriate water level. For example, (61 cm × 91.4 cm × 25.4 cm)(24 in × 36 in × 10 in).

## Symbol Descriptions

The following table describes the symbols on the consumable or consumable packaging.

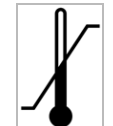
Symbol	Description
	The date the consumable expires. For best results, use the consumable before this date.
	Indicates the manufacturer (Illumina).
	The intended use is Research Use Only (RUO).
	Indicates the part number so that the consumable can be identified. <sup>1</sup>
	Indicates the batch code to identify the batch or lot that the consumable was manufactured in. <sup>1</sup>
	Indicates the serial number.
	Indicates that protection from light or heat is required. Store away from sunlight.
	Indicates a health hazard.
	Indicates a hazard warning.
	Storage temperature range in degrees Celsius. Store the consumable within the indicated range. <sup>2</sup>

<sup>1</sup> REF identifies the individual component, while LOT identifies the lot or batch the component belongs to.

<sup>2</sup> Storage temperature can differ from shipping temperature.

# System Configuration

The first time the system is turned on, the NovaSeq Control Software is launched with a series of screens to guide you through first time setup. First time setup includes performing a system check to confirm instrument performance and configuring system settings.

If you want to modify system settings after first time setup, select the System Settings command in the control software. The command opens the Settings, Network Access, and Customization tabs, where you can access all control software settings and Windows network settings.

## Operating System Accounts

For operating system accounts and password information, refer to [Technical Assistance on page 91](#).

## Validation Runs

Optionally perform a validation run before sequencing experimental libraries for the first time. A validation run sequences 100% PhiX, which functions as a control library, to confirm system operation. For instructions, refer to [Sequencing on page 49](#).

# Start the Instrument

1. Press the turn on (I) side of the toggle switch on the back of the instrument.

Figure 10 Power Switch Location

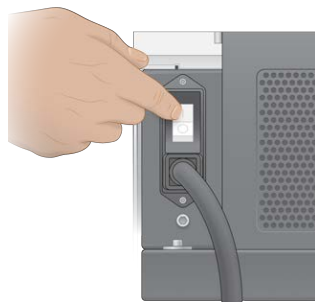

2. Wait until the power button on the right side of the instrument glows blue, and then press it.

Figure 11 Power Button Location

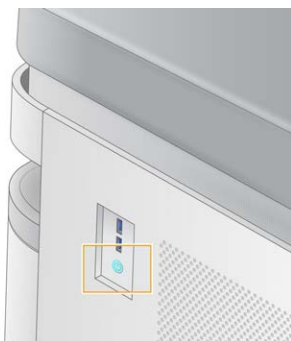

## User Accounts

In NVCS v1.5, and newer versions, there are two types of accounts: administrator and user. Permissions for each type are shown in the following table.

Permissions	Administrator	User
Set up, start, monitor sequencing runs	X	X
Download and update software	X	
View status for active run started by other user	X	
Terminate unresponsive UCS process	X	

Application data files are stored in C:/ProgramData. Applications are installed in C:/Program Files. The NVCS is launched as a full screen app for both types of accounts.

## Log On to the System

1. When the operating system is loaded, log on to Windows using the user name and password for your site.
2. Open the NVCS.  
The software is launched and initializes the system. When initialization is complete, the Home screen appears. The NVCS is launched as a user app. If you attempt to use a feature that requires administrator permissions, such as Software Update, and you are not logged in as an administrator, you will be prompted to login as an administrator.

To stay informed about the progress of a sequencing run, remain logged in while the NVCS is running and while a sequencing run is in progress.

## Configure Settings

The NVCS includes settings for the following:

- Run Mode (manual or file-based)
- NovaSeq Xp workflow
- Cloud hosting (BaseSpace Sequence Hub or Illumina Connected Analytics)
- Software Updates

**i** | Before configuring Workflow Selection or Automatic Checks for Software Updates, make sure that Mode Selection has been configured.

### Run Setup Modes

- **Manual**—The default mode that sends data to a specified output folder for later analysis.
- **File-Based**—A mode that uses files from BaseSpace Clarity LIMS or other LIMS system to define run parameters. For more information, refer to [Configure LIMS Output on page 28](#).
- **Server-Based**—A mode that uses a LIMS Server URL to define run parameters.

When configuring the run setup mode, be sure to specify an existing location for the run setup folder. This folder is required, and an invalid location message indicates that the specified location does not exist.

All run setup modes include the option to send data to BaseSpace Sequence Hub or Illumina Connected Analytics for data storage and analysis.

### Configure Manual Mode

1. From the Main Menu, select **Settings**.  
The Settings screen opens to the Mode Selection tab.
2. Select **Manual**.
3. [Optional] Enter or browse to a preferred network location for the output folder.  
Do not specify a location on the C:\, D:\, or Z:\ drives. Doing so causes an invalid drive error.  
This setting is the default location. The output folder location can be changed on a per-run basis.
4. [Optional] Select **Send Instrument Performance Data to Illumina** to enable the Illumina Proactive monitoring service. The name of the setting in the software interface might be different from the name in this guide, depending on the version of NVCS in use.  
With this setting turned on, instrument performance data are sent to Illumina. This data helps Illumina troubleshoot more easily and detect potential failures, enabling proactive maintenance and maximizing instrument uptime. For more information on the benefits of this service, see *Illumina Proactive Technical Note (document # 1000000052503)*.  
This service:



- Does not send sequencing data
- Requires that the instrument be connected to a network with internet access
- Is turned on by default. To opt out of this service, disable the **Send Instrument Performance Data to Illumina** setting.

5. Select **Save**.

## Configure File-Based Mode

1. From the Main Menu, select **Settings**.

The Settings screen opens to the Mode Selection tab.

2. Select **File-Based**.

3. Enter or browse to a preferred network location for the run setup folder, which contains LIMS files. Make sure that the appropriate LIMS files are added to the run setup folder before setting up a run. During run setup, the software uses the library tube ID or the flow cell ID to locate the files for the current run.

4. [Optional] Enter or browse to a preferred network location for the output folder.

Do not specify a location on the C:\, D:\, or Z:\ drives. Doing so causes an invalid drive error.

The output folder location can be changed on a per-run basis.

5. [Optional] Select **Send Instrument Performance Data to Illumina** to enable the Illumina Proactive monitoring service. The name of the setting in the software interface might be different from the name in this guide, depending on the version of NVCS in use.

With this setting turned on, instrument performance data are sent to Illumina. This data helps Illumina troubleshoot more easily and detect potential failures, enabling proactive maintenance and maximizing instrument uptime. For more information on the benefits of this service, see *Illumina Proactive Technical Note (document # 1000000052503)*.

This service:

- Does not send sequencing data
- Requires that the instrument be connected to a network with internet access
- Is turned on by default. To opt out of this service, disable the **Send Instrument Performance Data to Illumina** setting.

When enabled, this option requires an external internet connection.

6. Select **Save**.

## Configure LIMS Output

If your system is configured for file-based mode and you are using LIMS software other than BaseSpace Clarity LIMS, configure LIMS to generate a run setup file in JSON format. For the Standard workflow, the file name must match the library tube ID. The flow cell ID field in the file can be left blank. For the NovaSeq Xp workflow, the file name must match the flow cell ID, and the flow cell ID and the library ID must be specified in the file. The file name and values are not case-sensitive.

External LIMS software can use the NovaSeq LIMS API to interact with the NovaSeq 6000. Contact Illumina Technical Support for more information on the API endpoints or the LIMS server-based mode.

Field Name	Value
run_name	A preferred run name, which can contain alphanumeric characters, hyphens, and underscores
run_mode	One of the following modes: <ul style="list-style-type: none"> <li>• S1</li> <li>• SP</li> <li>• S2</li> <li>• S4</li> </ul>
workflow_type	NoIndex, SingleIndex, or DualIndex
librarytube_ID	The RFID of the library tube
sample_loading_type	NovaSeqStandard or NovaSeq Xp
Flowcell_ID	The ID of the flow cell
paired_end	True or False
read1	A value up to 251 (additional cycles of UMI reads possible to 259)
read2	A value up to 251 (additional cycles of UMI reads possible to 259)
index_read1	Any value
index_read2	Any value
output_folder	The path to the output folder with two backslashes for an escape sequence
Sample sheet	The path to a sample sheet or other file in CSV (*.csv) format with two backslashes for an escape sequence
use_basespace	True or False
basespace_mode	RunMonitoringOnly or RunMonitoringAndStorage
use_custom_read1_primer	True or False
use_custom_read2_primer	True or False
use_custom_index_read1_primer	True or False
use_custom_index_read2_primer	True or False

\* Rehybridization is not available in NVCS v1.4.0, or earlier.

Example \*.json file named H6655DMXX.json:

```

{
  "run_name": "2x151_PhiX",
  "run_mode": "S2",
  "workflow_type": "NoIndex",
  "sample_loading_type": "NovaSeqOBEM",
  "librarytube_ID": "NV1236655-LIB",
  "flowcell_ID": "H6655DMXX",
  "paired_end": true,
  "read1": 151,
  "read2": 151,
  "index_read1": 0,
  "index_read2": 0,
  "output_folder": "\\snt-prd-isi01\\NovaSeq\\SeqRuns",
  "attachment": "\\snt-prd-isi01\\NVSQ\\SampleSheet.csv",
  "use_basespace": false,
  "basespace_mode": null,
  "use_custom_read1_primer": false,
  "use_custom_read2_primer": false,
  "use_custom_index_read1_primer": false
}

```

## Configure Default Index Cycles

You can configure the default number of index cycles for the Standard workflow as follows.

1. From the Main Menu, select **Settings**.  
The Settings screen opens to the Mode Selection tab.
2. Select the **Workflow Selection** tab.
3. Enter the default number of index cycles in the **Index Cycles** field.
4. Select **Save**.

## NovaSeq Standard and NovaSeq Xp Workflows

The NovaSeq Standard and NovaSeq Xp workflows both use Illumina proprietary ExAmp chemistry.

- **Standard Workflow**

The NovaSeq Standard workflow automates two crucial steps of Illumina proprietary ExAmp cluster chemistry onboard the instrument.

- Preparation of ExAmp Master Mix
- Delivery of Master Mix to the flow cell

Onboard preparation and delivery of the Master Mix minimizes user interaction and reduces variability in the prepared mix.

As part of the run setup for the Standard workflow, a library tube containing the denatured and neutralized library pool at recommended concentration is inserted into position #8 of the cluster cartridge. For more information on recommended concentrations, refer to the NovaSeq 6000 Denature and Dilute Guide (document # 1000000106351). After run initiation, subsequent steps occur onboard the instrument and require no user interaction. This includes transfer of ExAmp reagents from the cluster cartridge to the library tube, preparation of reagents and library pool mix, and delivery of the prepared mix to all lanes of the flow cell.

After onboard clustering, a series of steps common to both workflows is carried out. These steps include application of a conditioning mix to the clustered flow cell and additional chemistry steps to prepare the clusters for sequencing by synthesis. The conditioning mix is prepared during the clustering process using reagents in the cluster cartridge and the library tube inserted during run set up. The conditioning mix helps boost the efficiency of clustering on the NovaSeq 6000 instrument.

- NovaSeq Xp Workflow

The NovaSeq Xp workflow enables loading of different libraries or library pools onto individual lanes of the NovaSeq flow cell using the NovaSeq Xp flow cell dock and a flow cell-specific consumable kit (NovaSeq Xp 2-Lane Kit or NovaSeq Xp 4-Lane Kit). The NovaSeq Xp Kit contains ExAmp reagents that are needed for clustering and the NovaSeq Xp manifold that is needed for lane loading.

The ExAmp/library mix is prepared and loaded onto individual lanes of the flow cell using the NovaSeq Xp flow cell dock and the NovaSeq Xp manifold. An automated liquid handler can be used for preparation of the ExAmp/library mix and delivery to the manifold for flow cell self-filling. When flow cell sample loading is completed, an empty library tube is inserted in position #8 of the cluster cartridge, the flow cell is placed on the instrument, and the sequencing run is initiated.

After the run is initiated, a series of steps common to both workflows is carried out. These steps include application of a conditioning mix to the clustered flow cell and additional chemistry steps to prepare the clusters for sequencing by synthesis. The conditioning mix is prepared during the clustering process using reagents in the cluster cartridge and mixed in the empty library tube inserted during run set up. The conditioning mix helps boost the efficiency of clustering on the NovaSeq 6000 instrument.

## Configure NovaSeq Xp Workflow

1. From the Main Menu, select **Settings**.  
The Settings screen opens to the Mode Selection tab.
2. Select the **Workflow Selection** tab.
3. To enable the NovaSeq Xp Workflow, select **Enable Workflow Selection**.
4. [Optional] To make NovaSeq Xp the default workflow, select **NovaSeq Xp**.
5. Select **Save**.

## Configure Cloud Options

Use the following instructions to configure the default settings for connecting to the cloud. During run setup, you can turn off cloud options for the current run or change settings for run monitoring and storage. Connecting to BaseSpace Sequence Hub or Illumina Connected Analytics requires an internet connection.

1. From the Main Menu, select **Settings**.  
The Settings screen opens to the Mode Selection tab.
2. Select the **Illumina Cloud Options** checkbox.
3. For Configuration, select from the following options:
  - **Run Monitoring and Storage**—Sends run data to the selected cloud hosting option for remote monitoring and data analysis. This option requires uploading a sample sheet with the run.
  - **Run Monitoring Only**—Sends InterOp, log, and other non-CBCL run files to BaseSpace Sequence Hub so runs can be monitored remotely.
4. From the Hosting Location drop-down menu, select **EU (Frankfurt)** or **USA (N. Virginia)**.  
This option determines where data is uploaded to.
5. If you have an Enterprise subscription for BaseSpace Sequence Hub or Illumina Connected Analytics do as follows.
  - a. Select the **Private Domain** checkbox.
  - b. Enter the domain name used for single sign-on to BaseSpace Sequence Hub or Illumina Connected Analytics.
6. Select **Save**.

## Sample Sheet Name

When running NVCS v1.3.1, or earlier, a sample sheet used for a runs and uploaded to BaseSpace Sequence Hub must be named SampleSheet.csv (case-sensitive). If the sample sheet is incorrectly named and Run Monitoring and Storage is enabled, BaseSpace Sequence Hub flags the run for attention. A flagged run can be queued for FASTQ generation by selecting **More | Fix Sample Sheet and Requeue** and then entering the appropriate sample sheet. Until the sample sheet is provided, sequencing data cannot be converted into FASTQ files.

If you are running NVCS v1.4 or later, there are no limitations on sample sheet names.

If you are using bcl2fastq2 Conversion Software v2.19, or later, to convert data to FASTQ files locally, you can use the command line option `--sample-sheet` to specify any CSV file in any location. The command line allows the use of any file name.

## Configure Software Updates

Automatic checking for software updates is enabled by default. You can disable, or enable, automatic checking for updates from Settings.

1. From the Main Menu, select **Settings**.
2. Select **Software Update**.
3. Select the **If enabled, the instrument will display a notification when a Software Update is available** checkbox.
4. Select **Save**.

# Standard Workflow: Preparing Consumables

## Best Practices

- Make sure that you have the required consumables and equipment. Refer to [User-Supplied Consumables and Equipment on page 19](#).
- Always check the label when you prepare consumables to ensure compatibility between components. Do not mix and match SP, S1, S2, and S4 components.
- Do not mix reagent kit versions.
  - v1.0 SBS & CPE cartridges should only be paired together.
  - v1.5 SBS & CPE cartridges should only be paired together.
- Follow the instructions in the order shown, using the specified volumes, concentrations, temperatures, and durations.
- Unless a stopping point is specified in the instructions, proceed immediately to the next step.

## Thaw SBS and Cluster Cartridges

1. If a sequencing run is in progress, make sure that both sides of the instrument will be available when the thaw is complete.
2. Remove the SBS and cluster cartridges from -25°C to -15°C storage.
3. Place each cartridge into a wire thaw rack.  
The racks are provided with the instrument and prevent capsizing in the water bath.

Figure 12 Cartridges in Wire Thaw Racks

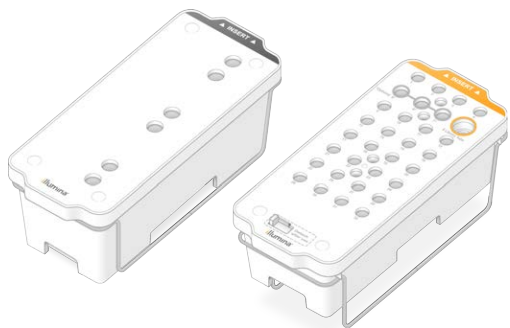

4. Thaw in a room temperature water bath (19°C to 25°C).  
Submerge about halfway.
5. Use the following table to determine thaw duration.

**!** Using hot water for thawing reagents may cause reduced data quality or run failure.

Cartridge	Duration of Thaw
SP, S1, and S2 SBS cartridge	4 hours
SP, S1, and S2 cluster cartridge	Up to 2 hours
S4 SBS cartridge	4 hours
S4 cluster cartridge	Up to 4 hours

6. Thoroughly dry the cartridge bases using paper towels. Dry between the wells so that all water is removed.
7. Inspect the foil seals for water. If water is present, blot dry with a lint-free tissue.
8. Inspect the underside of each cartridge to make sure that the reservoirs are free of ice, which indicates that the reagents are thawed.
9. Invert each cartridge 10 times to mix reagents.
10. Gently tap the bottom of each cartridge on the bench to reduce air bubbles.
11. If reagents cannot be loaded onto the instrument within 4 hours, store at 2°C to 8°C for up to 24 hours.

## Empty Used Reagent Bottles

Use the following instructions to empty the used reagent bottles with every sequencing run. The large bottle must be in place.

**!** **This set of reagents contains potentially hazardous chemicals. Personal injury can occur through inhalation, ingestion, skin contact, and eye contact. Wear protective equipment, including eye protection, gloves, and laboratory coat appropriate for risk of exposure. Handle used reagents as chemical waste and discard in accordance with applicable regional, national, and local laws and regulations.** For additional environmental, health, and safety information, refer to the SDS at [support.illumina.com/sds.html](https://support.illumina.com/sds.html).

1. Remove and empty the small used reagent bottle as follows.
  - a. Raise the lever and remove the small used reagent bottle from the alcove. Grasp the bottle by the sides.
  - b. Remove the threaded cap from the cap holder on the front of the bottle.
  - c. Seal the bottle opening with the cap to prevent spills.
  - d. Keeping the contents separate from the contents of the other bottle, discard in accordance with applicable standards for your region.



- e. Return the uncapped bottle to the alcove, and then lower the lever. Store the cap on the cap holder.
2. Remove and empty the large used reagent bottle as follows.
    - a. Using the top handle, remove the large used reagent bottle from the left side of the buffer drawer.
    - b. Remove the threaded cap from the cap holder on the front of the bottle.
    - c. Seal the bottle opening with the cap to prevent spills.
    - d. Discard the contents in accordance with applicable standards for your region. Grip both handles when emptying.
    - e. Return the uncapped bottle to the buffer drawer. Store the cap on the cap holder.

Figure 13 Returning the Empty Bottle

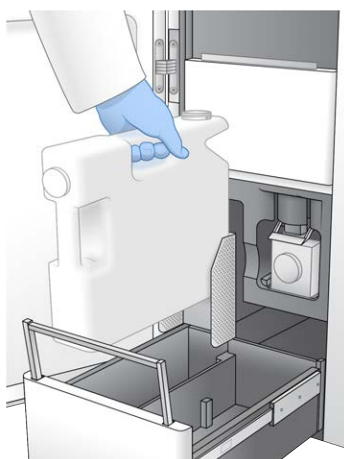

3. Put on a new pair of powder-free gloves.
4. Close the buffer drawer, and then close the liquid compartment doors.

**!** Failure to empty the used reagent bottles can result in a terminated run and overflow, which damages the instrument and poses a safety risk.

## Prepare Flow Cell

1. Remove a new flow cell package from 2°C to 8°C storage.
2. Set the sealed flow cell package aside at room temperature for 10–15 minutes.  
Use the flow cell within 12 hours of removing it from the package.

## Pool and Denature Libraries for Sequencing

Loading concentration can vary depending on library preparation, quantification, and normalization methods. For instructions, refer to the NovaSeq 6000 Denature and Dilute Guide (document # 1000000106351). Once your pooled library is ready proceed to [Prepare SBS and Cluster Cartridges on page 47](#).

- ! Store the library tube only if necessary. Long-term storage at -25°C to -15°C can increase duplicates, which decrease yield.

### Prepare SBS and Cluster Cartridges

1. Inspect the underside of each cartridge to make sure that the reservoirs are free of ice, which indicates that the reagents are thawed.
2. Invert each cartridge 10 times to mix reagents.
3. Gently tap the bottom of each cartridge on the bench to reduce air bubbles.

### Prepare Custom Primers

If your library requires custom primers, prepare them by following the instructions in the NovaSeq Series Custom Primers Guide (document # 1000000022266).

### Load Library Tube

1. Without disturbing the library at the bottom, insert the uncapped library tube containing the denatured and diluted library pool into the **Library Tube** position (#8) of the cluster cartridge.
2. Insert the library tube into position #8 of the cluster cartridge.

Figure 14 Uncapped Library Tube Loaded Into Position #8

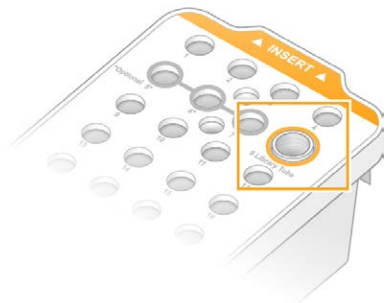

# NovaSeq Xp Workflow: Preparing Consumables

## NovaSeq Xp Workflow Summary

Before beginning preparation of samples or consumables, make sure that the NVCS version satisfies the minimum software requirements listed in the following table.

Table 11 Minimum Software Requirements

Flow cell	v1.0 Reagent Kit Minimum Software Version	V1.5 Reagent Kit Minimum Software Version
SP	1.6	1.7
S1	1.3.1	1.7
S2	All	1.7
S4	1.2.0	1.7

**i** | The NVCS supports staggered start of new runs. Refer to [Staggered Start of Runs on page 58](#).

Make sure that you complete all the steps in the NovaSeq Xp workflow, in the specified order.

**i** | Steps 1 through 4 can be completed in parallel, and must be completed before proceeding to step 5.

1. Thaw the SBS and cluster cartridges.
2. Empty used reagent bottles.
3. Set the sealed flow cell package aside for 10–15 minutes to allow the flow cell to reach room temperature. Use the flow cell within 12 hours of removing it from the package.
4. Normalize and pool libraries and optionally add PhiX control according to the appropriate protocol for your libraries in the NovaSeq 6000 Denature and Dilute Guide (document # 1000000106351).

**i** | Complete steps 5 through 11 in the specified order.

5. Thaw the ExAmp reagents.
6. Prepare a fresh dilution of NaOH according to the NovaSeq 6000 Denature and Dilute Guide (document # 1000000106351).
7. Denature and neutralize library pool according to the NovaSeq 6000 Denature and Dilute Guide (document # 1000000106351).
8. Prepare the flow cell and dock.

9. Prepare the ExAmp master mix.
10. Load ExAmp/library mix onto the flow cell.
11. Load an empty library tube into position #8 of the cluster cartridge.

## Methods

- Make sure that you have the required consumables and equipment. Refer to [User-Supplied Consumables and Equipment on page 19](#).
- Make sure that the instrument is turned on and has sufficient storage space for the run. Refer to [Process Management on page 10](#).
- Make sure the automatic post-run wash on both sides of the instrument is finished before starting the *Thaw the ExAmp reagents* step of the [NovaSeq Xp Workflow Summary on page 38](#).
- Always check the label when you prepare consumables to ensure compatibility between components. Do not mix SP, S1, S2, and S4 components or two-lane and four-lane components, on one side of the instrument.
- Do not mix reagent kit versions.
  - v1.0 SBS & CPE cartridges should only be paired together.
  - v1.5 SBS & CPE cartridges should only be paired together.
- Follow the instructions in the order shown, using the specified volumes, temperatures, and durations.
- When not actively mixing, place all reagents and libraries on ice.
- Unless a stopping point is specified in the instructions, proceed immediately to the next step.
- To successfully start sequencing for a two-lane flow cell, both lanes must be filled. To successfully start sequencing for a four-lane flow cell, one lane can be partially filled or empty.
- The most common causes for variations in results when mixing the ExAmp reagents manually are inaccurate delivery of ExAmp component volumes and insufficient mixing. Do not undermix.

**i** | Start the sequencing run immediately after loading libraries onto the flow cell, preferably within 30 minutes.

## Thaw SBS and Cluster Cartridges

1. If a sequencing run is in progress, make sure that both sides of the instrument will be available when the thaw is complete.
2. Remove the SBS and cluster cartridges from -25°C to -15°C storage.

- Place each cartridge into a wire thaw rack. The racks are provided with the instrument and prevent capsizing in the water bath.

Figure 15 Cartridges in Wire Thaw Racks

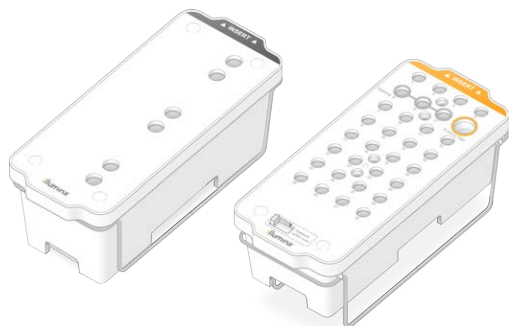

- Thaw in a room temperature water bath (19°C to 25°C). Submerge about halfway.
- Use the following table to determine thaw duration.

**!** Using hot water for thawing reagents may cause reduced data quality or run failure.

Cartridge	Duration of Thaw
SP, S1, and S2 SBS cartridge	4 hours
SP, S1, and S2 cluster cartridge	Up to 2 hours
S4 SBS cartridge	4 hours
S4 cluster cartridge	Up to 4 hours

- Thoroughly dry the cartridge bases using paper towels. Dry between the wells so that all water is removed.
- Inspect the foil seals for water. If water is present, blot dry with a lint-free tissue.
- Inspect the underside of each cartridge to make sure that the reservoirs are free of ice, which indicates that the reagents are thawed.
- Invert each cartridge 10 times to mix reagents.
- Gently tap the bottom of each cartridge on the bench to reduce air bubbles.
- If reagents cannot be loaded onto the instrument within 4 hours, store at 2°C to 8°C for up to 24 hours.

## Empty Used Reagent Bottles

Use the following instructions to empty the used reagent bottles with **every** sequencing run. The large bottle must be in place.

**!** This set of reagents contains potentially hazardous chemicals. Personal injury can occur through inhalation, ingestion, skin contact, and eye contact. Wear protective equipment, including eye protection, gloves, and laboratory coat appropriate for risk of exposure. Handle used reagents as chemical waste and discard in accordance with applicable regional, national, and local laws and regulations. For additional environmental, health, and safety information, refer to the SDS at [support.illumina.com/sds.html](http://support.illumina.com/sds.html).

1. Remove and empty the small used reagent bottle as follows.
  - a. Raise the lever and remove the small used reagent bottle from the alcove. Grasp the bottle by the sides.
  - b. Remove the threaded cap from the cap holder on the front of the bottle.
  - c. Seal the bottle opening with the cap to prevent spills.
  - d. Keeping the contents separate from the contents of the other bottle, discard in accordance with applicable standards for your region.
  - e. Return the uncapped bottle to the alcove, and then lower the lever. Store the cap on the cap holder.
2. Remove and empty the large used reagent bottle as follows.
  - a. Using the top handle, remove the large used reagent bottle from the left side of the buffer drawer.
  - b. Remove the threaded cap from the cap holder on the front of the bottle.
  - c. Seal the bottle opening with the cap to prevent spills.
  - d. Discard the contents in accordance with applicable standards for your region. Grip both handles when emptying.
  - e. Return the uncapped bottle to the buffer drawer. Store the cap on the cap holder.

Figure 16 Returning the Empty Bottle



3. Put on a new pair of powder-free gloves.

4. Close the buffer drawer, and then close the liquid compartment doors.

 Failure to empty the used reagent bottles can result in a terminated run and overflow, which damages the instrument and poses a safety risk.

## Prepare Flow Cell and Dock

1. Remove a new flow cell package from 2°C to 8°C storage.
2. Set the sealed flow cell package aside at room temperature for 10–15 minutes.  
Use the flow cell within 12 hours of removing it from the package.
3. Place the flow cell dock on a flat surface.
4. Inspect the dock and make sure that it is free from particulate.

## Thaw ExAmp Reagents

1. Remove one tube each of DPX1/JPX1, DPX2/JPX2, and DPX3 from -25°C to -15°C storage.
2. Thaw at room temperature for 10 minutes.
3. Set aside on ice.

 If you must refreeze unopened ExAmp reagents, do so immediately after thawing. ExAmp reagents can be refrozen one time only. Residual reagents cannot be frozen or combined.

## Check Flow Cell Vacuum Pressure

Check the flow cell vacuum as follows.

1. From the Main Menu, select **Tools**.
2. Select **Flow Cell Vacuum**.
3. Select the applicable side(s) that the flow cell(s) will be loaded on (Side A, Side B, or Both).
4. Select **Open**.

 The vacuum pressure state displays **Fail** on both side A and side B when first opening the flow cell vacuum tool. This is normal when a flow cell is not present or when a flow cell is loaded prior to the flow cell vacuum tool.

5. Remove the flow cell from the packaging as follows.
  - a. Put on a new pair of powder-free gloves to avoid contaminating the glass surface of the flow cell.
  - b. With the package over a flat surface, peel open the foil from the corner tab.
  - c. Remove the clear plastic retainer covering the flow cell.
  - d. Remove the flow cell from the package. Grasp the flow cell by the sides to avoid touching the glass or the underside gaskets.

- e. If particulate is visible on either of the glass surfaces, clean the applicable surface with a lint-free alcohol wipe and dry with a low-lint lab tissue.
- f. Discard the package appropriately.

**i** | Some scratches and other minor cosmetic defects on the flow cell are normal and not expected to compromise data quality and yield. Illumina recommends using these flow cells as per normal.

6. Align the flow cell over the four raised clamps and place it on the flow cell stage.

Figure 17 Loaded Flow Cells Aligned Over Clamps



7. Select **Close**.  
The flow cell door closes, the RFID and vacuum pressure are checked, and the flow cell descriptor, flow cell ID, and flow cell vacuum pressure state appear on the screen.
8. If the flow cell vacuum pressure state displays as Pass, select **Open** to open the flow cell door and proceed to [Load the Flow Cell on the Dock on page 44](#).  
If the flow cell vacuum pressure state displays as **Fail**:
  - a. Select **Open** to open the flow cell door
  - b. Remove the flow cell from the stage. Grasp the flow cell by the sides to avoid touching the glass or the underside gaskets.
  - c. Inspect that both the flow cell and the flow cell stage are free from particulates. If necessary, clean the applicable surface with a lint-free alcohol wipe and dry with a low-lint lab tissue.
  - d. Reload the flow cell by aligning the flow cell over the four raised clamps and place it on the flow cell stage.
  - e. Select **Close** to close the flow cell door.
  - f. If the flow cell vacuum pressure continues to fail, contact Illumina Technical Support.

## Pool, Denature, and Load Libraries for Sequencing

Loading concentration can vary depending on library preparation, quantification, and normalization methods. For instructions, refer to the NovaSeq 6000 Denature and Dilute Guide (document # 1000000106351). Once your pooled library is ready proceed to [Load the Flow Cell on the Dock on page 44](#).



## Load the Flow Cell on the Dock

1. Remove the flow cell from the package. Grasp the flow cell by the sides to avoid touching the glass or the underside gaskets.
2. If particulate is visible on either of the glass surfaces, clean the applicable surface with a lint-free alcohol wipe and dry with a low-lint lab tissue.
3. Discard the package appropriately.

**i** | Some scratches and other minor cosmetic defects on the flow cell are normal and not expected to compromise data quality and yield. Illumina recommends using these flow cells as per normal.

4. Invert the flow cell so that the top surface faces *downward*.
5. Slip the outlet end of the flow cell under the bracket and place it onto the dock. Refer to [Flow Cell on page 14](#) and [NovaSeq Xp Flow Cell Dock on page 18](#).

Figure 18 Flow Cell Placement

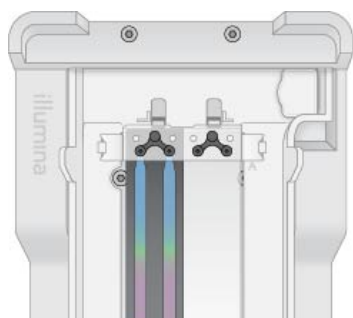

6. With the wells facing up, load the NovaSeq Xp manifold over the inlet end of the flow cell. Make sure that the NovaSeq Xp manifold arms fit securely into the dock cutouts.

Figure 19 NovaSeq Xp Manifold Placement

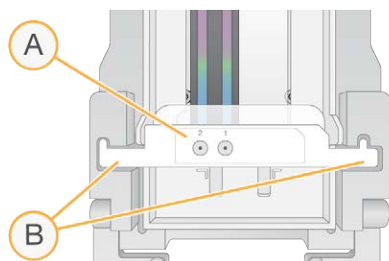

- A. NovaSeq Xp manifold wells facing up
- B. NovaSeq Xp manifold arms placed in dock cutouts

7. Close the clamp to secure the flow cell and NovaSeq Xp manifold and seal the gaskets.
8. Discard the NovaSeq Xp manifold after loading library pools into the flow cell.  
The NovaSeq Xp manifold is single use only.

## Prepare the ExAmp Master Mix

When preparing ExAmp master mix, use a microcentrifuge tube that holds at least twice the required volume:

- For two-lane flow cell, use a 0.5 ml or 1.7 ml tube.
- For four-lane flow cell, use a 1.7 ml tube.

The most common causes of variation in results when manually mixing ExAmp reagents are inaccurate delivery of volumes and insufficient mixing. Do not undermix.

**i** | The DPX1 and DPX2 consumables may be labeled as JPX1 and JPX2. Either are compatible with v1.0 or v1.5 reagent kits.

1. Invert or vortex briefly to mix DPX1/JPX1 and DPX2/JPX2.
2. Briefly vortex DPX3 to mix.  
ExAmp reagents might have separated in storage. They are viscous, especially DPX2/JPX2 and DPX3. DPX3 does not mix easily when inverted due to its high viscosity.
3. Briefly centrifuge DPX1/JPX1, DPX2/JPX2, and DPX3.
4. Combine the following volumes in a suitable microcentrifuge tube in the order specified.

Addition Order	Reagent*	Volume for Two-Lane Flow Cell (SP/S1/S2) (µl)	Volume for Four-Lane Flow Cell (S4) (µl)
1	DPX1/JPX1	126	315
2	DPX2/JPX2	18	45
3	DPX3	66	165

\*DPX/JPX reagent tube caps may be color coded (red, yellow, and blue for DPX1/JPX1, DPX2/JPX2, and DPX3, respectively). Make sure that color coding is preserved when replacing tube caps.

These volumes result in 210 µl ExAmp master mix for SP, S1, or S2 mode, or 525 µl Master Mix for S4 mode. These volumes are sufficient for the applicable mode. Extra volume is included to account for pipetting errors when loading libraries onto the flow cell.

5. Pipette and dispense slowly to avoid bubbles and make sure that entire volume is expelled from the tip.
6. Vortex for 20–30 seconds, or until thoroughly mixed.

**i** | The ExAmp master mix is stable to vortexing.

The mixture might appear cloudy, which is normal.

7. Centrifuge at up to 280 × g for up to 1 minute.
8. **For the best sequencing performance, immediately proceed to the next step. If necessary, ideal storage of the master mix is up to 1 hour on ice. Use within 30 minutes if storing at room temperature.**

## Load Libraries Onto the Flow Cell

For best results, do the following:

- Maintain the loaded flow cell at room temperature. Do not refrigerate or place on ice.
  - Prolonged incubation might reduce the percentage of clusters passing filter (%PF).
  - Start the run within 30 minutes after loading library pools on the flow cell.
  - Immediate use of the ExAmp/library mix yields best results.
1. Add ExAmp Master Mix to each denatured library pool as follows, and then vortex for 20–30 seconds to mix.

If using tube strips, pipette to mix until homogenous.

Mode	Denatured Library Pool (µl)	ExAmp Master Mix (µl)	Resulting Volume (µl)
SP/S1	27	63	<b>90</b>
S2	33	77	<b>110</b>
S4	45	105	<b>150</b>

2. Centrifuge at up to  $280 \times g$  for up to 1 minute.
3. Using a p200 µl pipette, add the appropriate volume of ExAmp/library mixture to each NovaSeq Xp manifold well.
  - To avoid creating bubbles, load samples slowly.
  - Make sure that you add the library pool mixture to the well that corresponds to the intended lane.
  - Avoid contact with the filter at the bottom of the well when pipetting.
  - It is not necessary to wait for a lane to fill completely before adding mixture to the remaining manifold wells.

Mode	Library/ExAmp Mixture per Well (µl)
SP/S1	80
S2	95
S4	130

The numbered NovaSeq Xp manifold wells match the number of the flow cell lane. When the flow cell is inverted, the lane numbering is reversed.

Figure 20 Inverted Lane Numbering

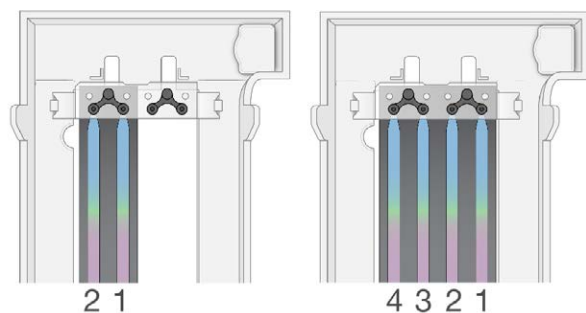

- After adding the ExAmp/library mixture to all manifold wells, wait approximately 2 minutes for the mixture to reach the opposite end of each lane.  
A small air bubble at the outlet end of the lane is normal. A small volume of the mixture may remain in the manifold wells after the lane is filled.

**!** Do not tilt the flow cell when trying to determine if lanes are filled or bubbles are present. Tilting can cause the ExAmp/library mixture to leak from the flow cell. If a lane does not fill completely, do not attempt to correct it. Data yield from the partially filled lane might be reduced. Do not attempt to retrieve the sample from the flow cell.

**i** Do not tilt the flow cell when transporting it.

## Prepare SBS and Cluster Cartridges

- Inspect the underside of each cartridge to make sure that the reservoirs are free of ice, which indicates that the reagents are thawed.
- Invert each cartridge 10 times to mix reagents.
- Gently tap the bottom of each cartridge on the bench to reduce air bubbles.

## Prepare Custom Primers

If your library requires custom primers, prepare them by following the instructions in the NovaSeq Series Custom Primers Guide (document # 1000000022266).

## Load Empty Library Tube

1. Uncap the library tube provided with the NovaSeq 6000 Reagent Kit.
2. Insert uncapped, empty library tube into the **Library Tube** position (#8) of the cluster cartridge. The empty library tube must be present for RFID scanning and onboard reagent mixing. The library tube barcode is not validated against the barcode specified in the LIMS file. The RFID is validated to make sure that the tube has not been used.

Figure 21 Uncapped Library Tube Loaded Into Position #8

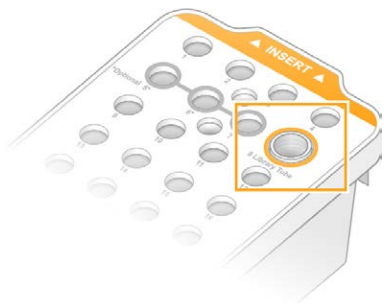

# Sequencing

## Set Up a Sequencing Run

Illumina recommends that you remain logged in while the NVCS is running and while a sequencing run is in progress.

1. Remove any items from the surface of the instrument.  
Keep the surface clear during the sequencing run and avoid leaning on the instrument. Pressure to the flow cell door can cause it to open, which stops the run. Stopped runs cannot be resumed.

**i** | Staggered start of new runs is supported. The staggered start timer indicates when a staggered run can be started. For more information, refer to [Staggered Start of Runs on page 58](#).

2. From the Home screen, select **Sequence**, and then select a single or dual flow cell run:
  - **A+B**—Set up a dual flow cell run.
  - **A**—Set up a single flow cell run on side A.
  - **B**—Set up a single flow cell run on side B.

The software initiates the series of run setup screens, starting with Load.

3. Select **OK** to acknowledge the warning and open the flow cell door.

### Load the Flow Cell Onto the Instrument

1. If present, remove the flow cell from the previous run.
2. If particulate is visible on the flow cell stage, clean the entire stage, including the fluidic interface and the glass surface of the optical alignment target, with an alcohol wipe. Dry with a lint-free tissue.

Figure 22 Flow Cell Stage

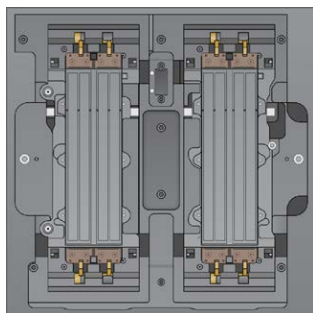

3. [Standard workflow] Remove the flow cell from the packaging as follows.

- a. Put on a new pair of powder-free gloves to avoid contaminating the glass surface of the flow cell.
- b. With the package over a flat surface, peel open the foil from the corner tab.
- c. Remove the clear plastic retainer covering the flow cell.
- d. Remove the flow cell from the package. Grasp the flow cell by the sides to avoid touching the glass or the underside gaskets.
- e. If particulate is visible on either of the glass surfaces, clean the applicable surface with a lint-free alcohol wipe and dry with a low-lint lab tissue.
- f. Discard the package appropriately.

**i** | Some scratches and other minor cosmetic defects on the flow cell are normal and not expected to compromise data quality and yield. Illumina recommends using these flow cells as per normal.

4. [NovaSeq Xp workflow] Unload the flow cell from the dock as follows.
  - a. Open the clamp that secures the flow cell and manifold.
  - b. Without allowing liquid to drip onto the flow cell, carefully remove and discard the manifold.
  - c. If liquid drips onto the flow cell, clean with a lint-free alcohol wipe and dry with a lint-free lab tissue.
  - d. Grasp the sides of the flow cell to remove it from the dock. Keep the flow cell level.
  - e. If there is residual material on the gaskets, blot the four flow cell gaskets with a lint-free tissue to dry. Do not touch the gaskets.
  - f. Invert the flow cell around the long axis so that the top surface faces up.

Figure 23 Invert Flow Cell Around Long Axis

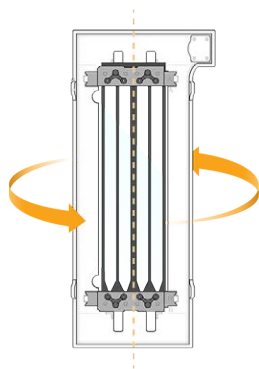

- g. Before returning the dock to storage, inspect it and make sure that it is free from particulate.
5. Align the flow cell over the four raised clamps and place it on the flow cell stage.

Figure 24 Loaded Flow Cells Aligned Over Clamps

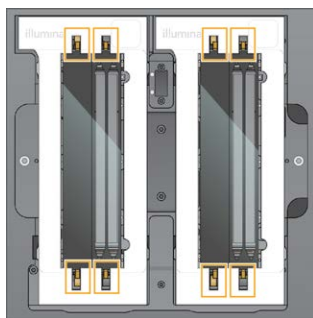

6. Select **Close Flow Cell Door**.

The flow cell door closes, the sensors and RFID are checked, and the flow cell ID appears on the screen.

## Load the SBS and Cluster Cartridges

**i** For the NovaSeq Xp Workflow, before loading the cluster cartridge, make sure the empty, uncapped library tube is loaded into the cartridge.

1. Open the liquid compartment doors, and then open the reagent chiller door.
2. Remove the used SBS and cluster cartridges.  
The used cartridges have pierced foil seals.
3. Dispose of unused contents in accordance with applicable standards.  
For safe disposal of position #30 of the cluster cartridge, refer to [Detach Position #30 on page 59](#).
4. Load the prepared cartridges into the reagent chiller drawer so that the **Insert** labels face the back of the instrument:
  - Place the SBS cartridge (gray label) into the left position.
  - Place the cluster cartridge (orange label) containing the uncapped library tube into the right position.

Figure 25 Loaded Reagent Cartridges



5. Slide the drawer into the chiller, and then close the reagent chiller door.



The sensors and RFIDs are checked. The IDs for the library tube and the two cartridges appear on the screen.

## Load the Buffer Cartridge

1. Pull the metal handle to open the buffer drawer.
2. Remove the used buffer cartridge from the right side of the buffer drawer.  
The used buffer cartridge has pierced foil seals.
3. Place a new buffer cartridge into the buffer drawer so that the **Illumina** label faces the front of the drawer. Align the cartridge with the raised guides on the drawer floor and sides.  
When properly loaded, the buffer cartridge is evenly seated and the drawer can close.

Figure 26 Load the Buffer Cartridge



4. If both used reagents bottles have been emptied, select the checkbox acknowledging that both used reagent bottles are empty.  
 Failure to empty the used reagent bottles can result in a terminated run and overflow, which damages the instrument and poses a safety risk.
5. Select the available button:
  - **Log In**—Opens the Log In screen to sign into your cloud account. For BaseSpace Sequence Hub, proceed to [Sign In to BaseSpace Sequence Hub on page 53](#). For Illumina Connected Analytics, proceed to [Sign In to Illumina Connected Analytics on page 53](#).
  - **Run Setup**—Skips BaseSpace Sequence Hub and opens the Run Setup screen to enter run parameters. Proceed to [Enter Run Parameters on page 53](#).

Which button is available depends on whether the system is configured for BaseSpace Sequence Hub.

## Sign In to BaseSpace Sequence Hub

When you open NVCS, your default workgroup from BaseSpace Sequence Hub is selected as your workgroup. If you did not specify a default, your personal workgroup is selected.

1. [Optional] Update BaseSpace Sequence Hub settings for the current run:
  - To disable BaseSpace Sequence Hub, clear the **BaseSpace Sequence Hub** checkbox and then select **Run Setup** to proceed without signing in.
  - To send run data to BaseSpace Sequence Hub for remote monitoring and data analysis, select **Run Monitoring and Storage**. This option requires a sample sheet.
  - To send InterOp files, runinfo.xml, and runParameters.xml to BaseSpace Sequence Hub to monitor the run remotely, select **Run Monitoring Only**.
2. Enter your BaseSpace Sequence Hub username and password, and then select **Sign In**.
3. If prompted, select a workgroup to upload run data to, and then select **Run Setup**.  
You are prompted only if you belong to multiple workgroups.

## Sign In to Illumina Connected Analytics

1. [Optional] Update the following Illumina Connected Analytics (ICA) settings for the current run:
  - To disable ICA, clear the Illumina Cloud Options checkbox, and then select **Run Setup** to proceed without signing in.
  - To send run data to ICA for remote monitoring and data analysis, select **Run Monitoring and Storage**. This option requires a sample sheet.
  - To send InterOp files, runinfo.xml, and runParameters.xml to ICA to monitor the run remotely, select **Run Monitoring Only**.
2. Enter your ICA user name and password, and then select **Sign In**.
3. When prompted, select a workgroup and project to upload run data to, and then select **Run Setup**.

## Enter Run Parameters

1. If the NovaSeq Xp workflow is enabled, select a workflow type.
  - If you select **NovaSeq Xp**, make sure that an empty library tube is loaded.
  - If you select **NovaSeq Standard**, make sure that the sample is loaded in the library tube.
2. In the Run Name field, enter a name of your preference to identify the current run.  
The run name can contain alphanumeric characters, hyphens, and underscores.

3. Enter the number of cycles for each read and index length in the sequencing run.

There is no maximum number of index cycles, but the sum of the read cycles and index cycles must be less than the number of cycles for the kit.

- **Read 1**—Enter a value up to 151 cycles for v1.0 300 cycle kits, or up to 251 for v1.0 500 cycle kits. Enter a value up to 159 cycles for v1.5 300 cycle kits, or up to 259 for v1.5 500 cycle kits.
- **Index 1**—Enter the number of cycles for the Index 1 (i7) primer.
- **Index 2**—Enter the number of cycles for the Index 2 (i5) primer.
- **Read 2**—Enter a value up to 151 cycles for v1.0 300 cycle kits, or up to 251 for v1.0 500 cycle kits. Enter a value up to 159 cycles for v1.5 300 cycle kits, or up to 259 for v1.5 500 cycle kits. This value is typically the same as the Read 1 value.

**i** | The number of cycles analyzed in Read 1 and Read 2 is one cycle less than the value entered. For example, to perform a paired-end 150-cycle run (2 × 150 bp run), enter the value of 151 cycles for Read 1 and Read 2.

For v1.0 kits, the sum of the four values entered can exceed the indicated number of cycles for the selected reagent kit by up to 23 cycles for paired-end runs, and 30 cycles for single-read runs.

For v1.5 kits, the sum of the four values entered can exceed the indicated number of cycles for the selected reagent kit by up to 38 cycles for both paired-end and single-read runs.

The S4 35 cycle kit contains a total of 72 sequencing cycles. The sum of the four values can exceed the indicated number by a maximum of 37 cycles. The default read values are editable and the number of cycles can be distributed across the 4 reads, e.g.: 36, 10, 10, 0.

4. Expand **Advanced Options** to apply settings for the current run.

These settings are optional unless otherwise indicated.

- **v1.0 Custom Primers**—Select the **Custom Primers** checkbox, and then select the appropriate checkboxes. Illumina DNA PCR-Free Prep, Tagmentation libraries require custom Read 1 (VP10) sequencing primer if using v1.0 kits. Refer to the NovaSeq Series Custom Primers Guide (document # 1000000022266) for details.
  - **Read 1**—Use custom primer for Read 1.
  - **Read 2**—Use custom primer for Read 2.
  - **Custom Index**—Use custom primer for Index 1.
- **v1.5 Custom Primers**—Select the **Custom Primers** checkbox, and then select the appropriate checkboxes. Illumina DNA PCR-Free Prep, Tagmentation libraries do not require custom primer if using v1.5 kits. Refer to the NovaSeq Series Custom Primers Guide (document # 1000000022266) for details.
  - **Read 1**—Use custom primer for Read 1.
  - **Read 2**—Use custom primer for Read 2.

- **Custom Index**—Use custom primer for both Index 1 and Index 2 reads.
- **Output Folder**—Select **Browse** to change the output folder for the current run. An output folder is required when the run is not connected to BaseSpace Sequence Hub or Illumina Connected Analytics for storage.
- **Samplesheet**—Select **Browse** to upload a sample sheet, which is required when using BaseSpace Sequence Hub or Illumina Connected Analytics for run monitoring and storage, or other CSV file. The CSV file is copied to the output folder and does not affect run parameters. Ensure uploaded sample sheet is in the appropriate format (Index Read 2 adapter direction) based on v1.0 and v1.5 workflows which utilize different strategies. Forward strand workflow is performed with v1.0 reagent kits. Reverse complement workflow is performed with v1.5 reagent kits.
- **Custom Recipe**—Select **Custom Recipe**, then **Browse** to use a custom recipe in XML format for this run. Custom recipes for v1.0 will not be compatible for v1.5. Contact Illumina Technical Support for more information.

 | Modifying the clustering steps in a custom recipe is not supported.

5. Select **Review**.

The software confirms that the specified parameters are appropriate for the recipe.

## Confirm Run Parameters

1. Confirm the run parameters displayed on the Review screen.
2. [Optional] Select **Back** to return to the Run Setup screen and edit run parameters.
3. Select **Start Run**.  
The pre-run checks are started automatically.

## Review Pre-Run Checks

1. Wait about 5 minutes for the pre-run check to complete.  
The run starts automatically after successful completion.  
 | To avoid overfilling the hard drive, do not copy any data to C:\ after the run starts.
2. If pre-run checks fail due to a sensor error, such as flow cell not detected, you must exit and restart the workflow.
3. For other pre-run check failures, select **Retry** to restart the failed check or **Retry All** to restart all checks.  
Errors require resolution before the run can start. Refer to [Pre-Run Check Errors on page 67](#) for troubleshooting information.
4. Select the **Error** icon to see error details.

5. If the alignment check fails, resolve the error as follows.
  - a. Select **Reload**, and then select **OK** to return to the Load screen.
  - b. Remove any items from the top of the instrument, and then select **OK**. The flow cell door opens.
  - c. Reload the flow cell, and then select **Run Setup**.
  - d. Proceed through each screen to reread each RFID and return to the Pre-Run Checks screen.
  - e. Redo the check.

## Monitor Run Progress

1. Monitor run progress, intensities, and quality scores as metrics appear on the screen. For more information on run metrics, refer to [Real-Time Analysis on page 72](#).

Figure 27 Sequencing Run Progress and Metrics



- Time to completion**—The run completion date and time (yyyy-mm-dd hh:mm).
- Run progress**—The current run step. The size of the progress bar is not proportional to the run rate of each step.
- Q-scores**—The distribution of quality scores (Q-scores).
- Intensity**—The value of cluster intensities of the 90<sup>th</sup> percentile for each tile. Plot colors indicate the red and green channels.
- Clusters passing filter (%)**—The percentage of clusters passing filter.
- Projected Total Yield (Gb)**—The projected yield for the FC run. If the per lane metrics are selected (H) the numbers displayed are the current yield per lane, and will update per cycle throughout the run.
- Q30**—The percentage of base calls for the run that have a Q-score of  $\geq 30$ .
- Per lane breakdown** Selecting the values in items E, F, and G will display a per lane breakdown of data for each of those fields.

**i** | If a shutdown or restart is initiated while the NVCS is running, confirm this action before the shutdown or restart can proceed.

## Run Metrics

The software displays metrics generated during the run. Metrics appear in the form of plots, graphs, and tables based on data generated by RTA3 and written to InterOp files.

Clustering takes approximately 2 hours, then sequencing begins with cycle 1. Metrics are updated as sequencing progresses. Clusters passing filter, yield, and quality scores are available after cycle 26. Prior to cycle 26, no values are populated and are designated as not applicable.

## Processing Status

The Process Management screen lists the status of each run. From the Main Menu, select **Process Management**.

For each run name, Process Management lists the status of the following processes:

- **Run Status**—Based on the processing of CBCL files.
- **Network**—Based on file transfer using Universal Copy Service.
- **BaseSpace**—Based on file upload to BaseSpace Sequence Hub, if applicable.

When a process is complete, a green checkmark appears. For more information, refer to [Process Management on page 10](#).

## Staggered Start of Runs

You can set up and start a run on the idle side of the instrument while a run is in progress on the other side, which is referred to as a staggered start. Staggered runs are set up at specific times during a run, as indicated by the following start countdown timer states.

- **Run Start: Available**—Staggered start is available. The date and time show when staggered start will become unavailable. Select **Sequence** to start a new staggered run after the current cycle is complete.
- **Run Start: Unavailable**—Staggered start is unavailable. The date and time show when staggered start will be available on the other side of the instrument.
- **Waiting...**—If a new run is attempted when staggered start is unavailable, the state changes to Waiting and the date and time show the approximate time that the instrument will be ready for the new run. The instrument proceeds to run setup when staggered start is available.

When you set up the new run, the software automatically pauses and resumes the run on the adjacent flow cell as needed. The system is placed in a safe state when paused.

## Procedure

1. From the home screen, select **Sequence**, and then select **A** or **B**.  
The selected side must be the currently idle side.
2. Wait for the run on the adjacent flow cell to pause. To cancel the new run and prevent pausing, select **Cancel**.  
If the adjacent run is performing cluster generation, paired-end resynthesis, imaging, or washing, the software completes the current step before pausing.
3. When the adjacent run is paused and the flow cell door opens, set up the new run.

After the new run is started, the paused run automatically resumes.

## Delete the Run

After data transfer is complete, you can delete the current run from Process Management to clear space for a subsequent run. Deleting the run clears CE and C:\ without removing system maintenance files, affecting the network, or affecting the BaseSpace Sequence Hub copy. Runs that are sequencing cannot be deleted.

1. From the Main Menu, select **Process Management**.
2. [Optional] Make sure that each process for the run displays a green checkmark, which indicates that data transfer is complete.  
You can delete a run that has not completed transfer to a network or BaseSpace Sequence Hub, but all run data are lost.
3. Select **Delete Run**, and then select **Yes** to confirm.
4. Select **Done**.

## Detach Position #30

The reservoir in position #30 of the cluster cartridge contains formamide. It is removed from the used cluster cartridge and discarded separately.

**!** | **This set of reagents contains potentially hazardous chemicals. Personal injury can occur through inhalation, ingestion, skin contact, and eye contact. Wear protective equipment, including eye protection, gloves, and laboratory coat appropriate for risk of exposure. Handle used reagents as chemical waste and discard in accordance with applicable regional, national, and local laws and regulations.** For additional environmental, health, and safety information, refer to the SDS at [support.illumina.com/sds.html](https://support.illumina.com/sds.html).

1. While wearing gloves, push the white plastic tab labeled **Detach after use** to the right.
2. Place a hand or solid surface under the reservoir and pressPress the clear plastic tab toward the Illumina label to release the reservoir from under the cluster cartridge.

**i** | Avoid stacking cluster cartridges when storing. Stacking might cause accidental detachment of the reservoir.



Figure 28 Removable Position #30

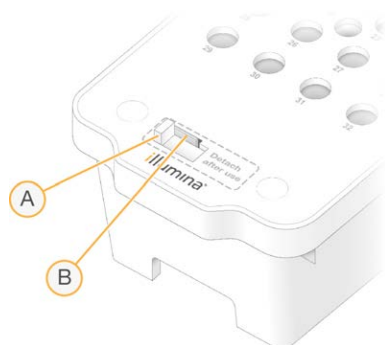

- A. White plastic tab to detach
- B. Clear plastic tab to release

3. Dispose of the reservoir in accordance with applicable standards.

## Automatic Post-Run Wash

When sequencing is complete, the software initiates an automatic post-run wash that takes about 80 minutes. The system pumps 0.24% sodium hypochlorite (NaOCl) from position #17 and dilutes it to 0.12%. The 0.12% NaOCl is pumped to the ExAmp reagent and library positions, through the flow cell, and then to the used reagent bottles. The wash flushes template from the system to prevent cross-contamination.

When the wash is complete, the system is placed in a safe state and the Home button becomes active. Leave consumables in place until the next run. After the wash, the sippers remain in the SBS and cluster cartridges to prevent air from entering the system. The sippers in the buffer cartridge are raised so the used reagent bottles can be emptied.

- i** | If an error occurs during an automatic post-run wash, and the post-run wash is incomplete, a maintenance wash is required.

# Maintenance

## Preventive Maintenance

Illumina recommends that you schedule a preventive maintenance service each year. If you are not under a service contract, contact your Territory Account Manager or Illumina Technical Support to arrange for a billable preventive maintenance service.

## Perform a Maintenance Wash

The software prompts for a maintenance wash at the following times:

- When there has not been a four-lane run with a post-run wash within the last 14 days.
- When there has not been a maintenance wash within the last 14 days.
- When a post-run wash fails or is incomplete.

The maintenance wash flushes the system with user-supplied dilutions of Tween 20 and NaOCl. The dilutions are pumped from the wash cartridges to the flow cell, used reagent bottles, and each cartridge reservoir to wash all sippers. Wash duration is about 80 minutes.

A maintenance wash requires a used buffer cartridge and the SBS wash cartridge, cluster wash cartridge, and four-lane wash flow cell provided with the instrument (or a used four-lane flow cell). Like the reagent cartridges, the wash cartridges are color-coded to prevent loading errors. The SBS wash cartridge has a center well for the Tween 20 dilution. The NaOCl dilution is added to a reservoir on the cluster wash cartridge.

 Failure to empty the used reagent bottles can result in a terminated wash and overflow, which damages the instrument and poses a safety risk.

Figure 29 SBS Wash Cartridge (Left) and Cluster Wash Cartridge (Right)



## Prepare Wash Solution

1. Add 400 ml laboratory-grade water to a 500 ml centrifuge bottle.
2. Add 0.2 ml 100% Tween 20 to result in at least 400 ml 0.05% Tween 20 wash solution.  
Using a freshly prepared dilution of Tween 20 limits the introduction of contaminants into the fluidics system.
3. Invert to mix.
4. Remove the lid from the center well of the SBS wash cartridge.
5. Add wash solution to the center well. Fill to the MIN FULL VOLUME line, which indicates the minimum required volume.  
The other reservoirs remain empty.

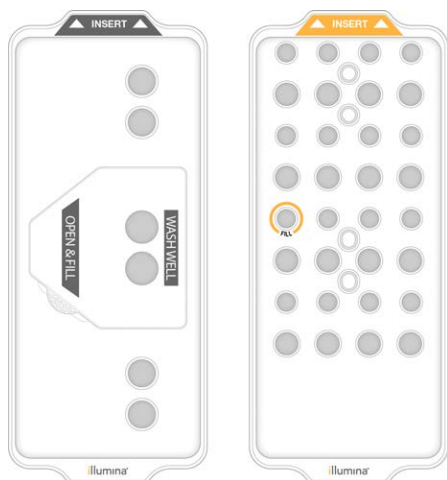
Figure 30 Center Well Filled to MIN FILL VOLUME Line



6. Combine the following volumes in a 30 ml centrifuge tube to prepare 20 ml of 0.25% reagent grade NaOCl:
  - 5% reagent grade NaOCl (1 ml)
  - Deionized water (19 ml)

- ! Only use reagent grade NaOCl. Avoid general-purpose bleach products as these can contain ammonia compounds, which may lead to runs with low percentage passing filter reads.

7. Invert to mix.
8. Add 5 ml 0.25% reagent grade NaOCl cartridge.
 

The location is marked Fill and has an orange circle around it. All other reservoirs remain empty.

The location is marked Fill and has an orange circle around it. All other reservoirs remain empty.

Figure 31 Position for 0.25% NaOCl

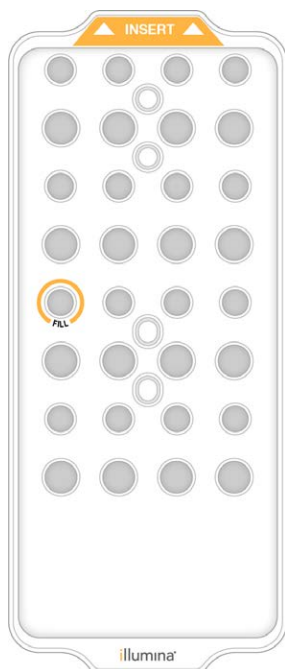

## Load the Wash Flow Cell

1. Remove any items from the surface of the instrument.
 

Keep the surface clear during the maintenance wash and avoid leaning on the instrument. Pressure to the flow cell door can cause it to open, which stops the wash.
2. From the home screen, select **Wash**, and then select which side to wash:
  - **A+B**—Wash both sides simultaneously.
  - **A**—Wash side A only.
  - **B**—Wash side B only.

The software initiates the series of wash screens.

- i | A maintenance wash for a single side can only be started when the other side is either idle or performing SBS read cycles. The NVCS staggered start time indicates the availability for starting a new run or a wash. Refer to [Staggered Start of Runs on page 58](#).

3. Select **OK** to acknowledge the warning and open the flow cell door.

4. If not already present, load a wash flow cell or a used 4-lane flow cell.
5. Select **Close Flow Cell Door**.  
The door closes, the sensors and RFID are checked, and the flow cell ID appears on the screen.

## Load the Wash Cartridges

Wash cartridges are required for a maintenance wash. Do not use the used SBS and cluster cartridges.

1. Open the liquid compartment doors, and then open the reagent chiller door.
2. Remove the used SBS and cluster reagent cartridges. Dispose of unused contents in accordance with applicable standards for your region.  
For safe disposal of position #30 of the cluster cartridge, refer to [Detach Position #30 on page 59](#).
3. Load the wash cartridges into the reagent chiller drawer so that the **Insert** labels face the back of the instrument:
  - Place the SBS cartridge (gray label) into the left position.
  - Place the cluster cartridge (orange label) into the right position.
4. Slide the drawer into the chiller, and then close the reagent chiller door.  
The sensors are checked and the RFID for each cartridge is scanned and displayed on the screen.
5. Open the buffer drawer.
6. If not already present, load a used buffer cartridge.

## Empty Used Reagent Bottles

Use the following instructions to empty the used reagent bottles with every maintenance wash. Even if your system is configured to route used reagents externally, the small bottle collects used reagents and the large bottle must be in place.

 **This set of reagents contains potentially hazardous chemicals. Personal injury can occur through inhalation, ingestion, skin contact, and eye contact. Wear protective equipment, including eye protection, gloves, and laboratory coat appropriate for risk of exposure. Handle used reagents as chemical waste and discard in accordance with applicable regional, national, and local laws and regulations.** For additional environmental, health, and safety information, refer to the SDS at [support.illumina.com/sds.html](http://support.illumina.com/sds.html).

1. Remove the small used reagent bottle and discard the contents in accordance with applicable standards for your region. Keep the contents separate from the contents of the other bottle.
2. Return the small used reagent container to the alcove.
3. Remove the large used reagent bottle and discard the contents in accordance with applicable standards.
4. Return the large used reagent bottle to the buffer drawer.
5. Put on a new pair of powder-free gloves.

- Close the buffer drawer, and then close the liquid compartment doors.  
The sensors and RFIDs are checked. The ID of each wash component appears on the screen.

## Start the Wash

- Select the checkbox acknowledging that both used reagent bottles are empty, and then select **Start Wash**.

The wash starts and the estimated time of wash completion is displayed.

 Failure to empty the used reagent bottles can result in a terminated wash and overflow, which damages the instrument and poses a safety risk.

- When the wash is complete, select **Home**.
- Leave the consumables in place until the next run.  
The sippers remain in the SBS and cluster cartridges to prevent air from entering the system. The sippers in the buffer cartridge are raised so that the used reagent bottles can be emptied.

## Software Updates

Software updates are available for NVCS v1.4 or later. Software updates can be downloaded and installed from NVCS. Automatic checking for software updates is enabled by default. You can enable or disable automatic updates from Settings.

 The NovaSeq 6000 must be connected to the internet to check for software updates and to download updates.

The automatic check for updates is performed every 24 hours. A notification is displayed on the Main Menu when an update is available. The update notification is visible to all users, but only an administrator can download and install updates.

For the NovaSeq Xp workflow, make sure that the NVCS version satisfies the minimum software requirements listed in the following table before beginning preparation of samples or consumables.

Table 12 Minimum Software Requirements

Flow cell	v1.0 Reagent Kit Minimum Software Version	V1.5 Reagent Kit Minimum Software Version
SP	1.6	1.7
S1	1.3.1	1.7
S2	All	1.7
S4	1.2.0	1.7

**i** | You cannot update the software if a sequencing run, wash, run setup, or file transfer to output folder or to BaseSpace Sequence Hub is in progress. If a NovaSeq Xp workflow is in progress, wait to update the software until the libraries have been loaded onto the flow cell and sequencing has completed.

To manually check for updates, or to download and install an update, do the following:

1. From the Main Menu, select **Software Update**.

The Software Update screen is displayed, which provides release notes for the available update. If automatic checking for software updates is not enabled, you can manually check for updates, or enable automatic checking.

2. To download and install the update, select the checkbox to acknowledge that the download and installation takes approximately 30 minutes.

3. Select **Download and Install**.

When the download is finished, NVCS closes and the installer is launched. Follow the installer instructions to complete the installation.

If errors occur during download or installation, contact Illumina Technical Support.

# Troubleshooting

## Troubleshooting Resources

For technical questions, visit the [NovaSeq 6000 Sequencing System support page on the Illumina website](#). The support page provides access to documentation, downloads, and frequently asked questions. For access to support bulletins, sign in to your MyIllumina account.

For run quality or performance problems, contact Illumina Technical Support. Refer to [Technical Assistance on page 91](#). To facilitate troubleshooting, consider sharing a link to the run summary in BaseSpace Sequence Hub with Illumina Technical Support.

## Troubleshooting Files

Key File	Folder	Description
Run information file (RunInfo.xml)	Root folder	Contains the run settings: <ul style="list-style-type: none"> <li>• Number of cycles in the run</li> <li>• Number of reads in the run</li> <li>• Whether the read is indexed</li> <li>• Number of swaths and tiles on the flow cell</li> </ul>
Run parameters file (RunParameters.xml)	Root folder	Contains the run name and information about run parameters and run components, including the following RFID information: serial numbers, lot numbers, expiration dates, and catalog numbers.
InterOp files (*.bin)	InterOp	Binary reporting files used for Sequencing Analysis Viewer. InterOp files are updated throughout the run.
Log files	Logs	Log files describe each step performed by the instrument for each cycle, including which reagent is used, and list software and firmware versions used with the run. The file named <code>[InstrumentName]_CurrentHardware.csv</code> lists the serial numbers of instrument components.

## Pre-Run Check Errors

If an error occurs during the pre-run checks, use the following actions to resolve it. If you are setting up a dual flow cell run and one side fails, you can cancel the failed side and proceed with the side that passed.



When a pre-run check fails, the RFIDs for the flow cell, reagents, and buffers are not locked so the consumables can be used for a subsequent run. When the run is started, the sippers pierce the foil seals on the reagent cartridges and all RFIDs are locked.

System Check	Reason for Failure	Recommended Action
Sensors	A compartment door is open, a consumable is not properly loaded, or at least one sensor is not functional.	Select <b>Retry</b> and follow the onscreen prompts to resolve the error.
Disk Space	Disk space is insufficient because the specified location of the output folder is full.	Use the Process Management screen to clear disk space from the specified output folder location.
System Connectivity	The connection to RTA3, the fluidics system, or other connection has been interrupted.	Select <b>Retry</b> and follow the onscreen prompts to resolve the error.
Alignment	The position of the flow cell prevents imaging.	Follow the onscreen prompts to reload the flow cell.

## Leak Tray

A leak tray is built into the base of the instrument to collect leaked reagents or coolant and collect overflow from the used reagent bottles. Under normal conditions, the leak tray is dry. Leakage indicates a problem with the instrument, and overflow occurs when the used reagent bottles are not regularly emptied.

During the pre-run check, sensors detect whether the leak tray contains any liquids:

- If the leak tray contains liquid but is not full, the run can proceed but you must contact Illumina Technical Support. Refer to [Technical Assistance on page 91](#).
- If the leak tray is full, the run cannot proceed and you must contact Illumina Technical Support.

 Empty the used reagent bottles with **every run**. Runs are stopped if either of the used reagent bottles is full. Overflow from either of the used reagent bottles damages the instrument, requires a site visit from an Illumina representative, and poses a safety risk.

## Process Management Troubleshooting

The following table provides troubleshooting options for the N/A icon on the Process Management screen:

- The N/A icon is displayed in the BaseSpace column and the run is configured to upload to BaseSpace Sequence Hub.

- The N/A icon is displayed in the Network column and the run is configured to upload an output folder on the network.

Run Status	Troubleshooting Action
A run is in progress	Close the Process Management screen, wait about 5 minutes, and then reopen the screen.
A run is not in progress	Shut down and restart the instrument, and then reopen the Process Management screen.

If the N/A icon is still displayed after the troubleshooting action is complete, contact Illumina Technical Support. Refer to [Technical Assistance on page 91](#).

## Run Failure Before Clustering

If the software fails the run before clustering starts, you can save the reagent cartridges, library tube (including sample), and, if reused immediately, the flow cell, for a new run. When clustering starts, sippers pierce the foil seals and reagents are transferred to the library tube and flow cell, so the consumables and libraries cannot be used for another run.

You have two options for setting up a new run using the reagent cartridges, library tube, and flow cell saved from the failed run:

- **Set up a new run immediately**—Set up the new run within 4 hours of the failed run. The reagent cartridges, library tube, and flow cell remain loaded.

**i** | For optimal results for a NovaSeq Xp workflow, start the new run as soon as possible.

- **Set up a new run later**—Set up the new run within three weeks of the failed run. The reagent cartridges and library tube are unloaded from the instrument and stored. The saved consumables should be labeled with the date and stored under original conditions.

**i** | The flow cell cannot be reused and must be discarded. Contact Illumina Technical Support to obtain a replacement flow cell.

### Set Up a New Run Immediately

If a failed run used the NovaSeq Xp workflow, start the new run as soon as possible for optimal results.

1. When the run fails and the other side of the instrument is idle, reboot the instrument. Otherwise, select **Home**.
2. Set up a new run.
3. Leave the current flow cell in place.
4. Open and close the reagent chiller door and the buffer drawer to prompt the NVCS to reread the reagent cartridge RFIDs.

The cartridges, library tube, and flow cell can remain in the instrument for up to 4 hours after the failed run.

5. Empty the used reagent bottles, if needed, and return them to the instrument.
6. Proceed with run setup.

## Set Up a New Run Later

1. When the run fails, select **Home**.
2. Set up a new run or a maintenance wash to release the consumables from the instrument.
3. When prompted, remove and store the following consumables:
  - Cap the library tube and store at -25°C to -15°C for up to three weeks.
  - Return the SBS and cluster cartridges to -25°C to -15°C storage.
  - Return the buffer cartridge to room temperature storage protected from light.If not pierced, the cartridges can be reused in a new run.
4. Select **End** to cancel the run or maintenance wash, and then select **Yes** to confirm the command. You can let the maintenance wash complete instead of canceling it.

## End a Run

Ending a run on the NovaSeq 6000 system is *final*. The software cannot resume the run or save sequencing data, and consumables cannot be reused.

1. Select **End**, and then select **Yes** to confirm the command.  
If the run was ended after Read 1, the software initiates the automatic post-run wash.
2. If prompted, select from the following wash options:
  - **End Run Without Wash**—End the run and initiate a maintenance wash.
  - **End Run and Wash**—End the run and perform an automatic post-run wash.
  - **Cancel**—Continue with the current run.If the run is ended between clustering completion and Read 1 completion, the software displays the wash options. Otherwise, the software initiates the automatic post-run wash.
3. If you selected End Run Without Wash, follow the software prompts to set up a maintenance wash.

## Shut Down the Instrument

Shutting down the instrument safely shuts down all software and systems, and turns off instrument power. The status bar fades from green to white, indicating that the shutdown is in progress.

Under normal circumstances, shutting down the instrument is unnecessary.

A full instrument shutdown and power up should be performed any time a software crash event occurs.

If a shutdown or restart is initiated while the NVCS is running, the user must confirm this action before the shutdown or restart can proceed.

1. From the Main Menu, select **Shutdown Instrument**.
2. After the screen goes blank, switch the toggle power switch on the back of the instrument to the off position.
3. Wait at least 60 seconds before turning on the instrument again.

 Do not relocate the instrument. Improper moving can affect optical alignment and compromise data integrity. For relocation assistance, contact your Illumina representative.

# Real-Time Analysis

## Real-Time Analysis Overview

The NovaSeq 6000 Sequencing System runs RTA3, an implementation of Real-Time Analysis software, on the instrument Compute Engine (CE). RTA3 extracts intensities from images received from the camera, performs base calling, assigns a quality score to base calls, aligns to PhiX, and reports data in InterOp files for viewing in Sequencing Analysis Viewer.

To optimize processing time, RTA3 stores information in memory. If RTA3 is terminated, processing does not resume and any run data being processed in memory is lost.

### RTA3 Inputs

RTA3 requires tile images contained in local system memory for processing. RTA3 receives run information and commands from the NVCS.

### RTA3 Outputs

Images for each color channel are passed in memory to RTA3 as tiles. From these images, RTA3 outputs a set of quality-scored base call files and filter files. All other outputs are supporting output files.

File Type	Description
Base call files	Each tile that is analyzed is included in a concatenated base call (*.cbcl) file. Tiles from the same lane and surface are aggregated into 1 *.cbcl file for each lane and surface.
Filter files	Each tile produces a filter file (*.filter) that specifies whether a cluster passes filters.
Cluster location files	Cluster location (*.locs) files contain the X,Y coordinates for every cluster in a tile. A cluster location file is generated for each run.

Output files are used for downstream analysis in BaseSpace Sequence Hub. Alternatively, use bcl2fastq conversion software for FASTQ conversion and third-party analysis solutions. NovaSeq files require bcl2fastq2 Conversion Software v2.19, or later. For the latest version of bcl2fastq2, visit the [bcl2fastq downloads page](#) on the Illumina website.

RTA3 provides real-time metrics of run quality stored as InterOp files, which are a binary output containing tile, cycle, and read-level metrics. Viewing real-time metrics using Sequencing Analysis Viewer requires InterOp files. For the latest version of Sequencing Analysis Viewer, visit the [Sequencing Analysis Viewer downloads page](#) on the Illumina website.

## Error Handling

RTA3 creates log files and writes them to the Logs folder. Errors are recorded in a text file in \*.log file format.

The following log files are transferred to the final output destination at the end of processing:

- info\_00000.log summarizes important run events.
- error\_00000.log lists errors that occurred during a run.
- warning\_00000.log lists warnings that occurred during a run.

## Flow Cell Tiles

Tiles are small imaging areas on the flow cell. The camera takes one image of each swath, which the software divides into tiles for RTA3 processing. The total number of tiles depends on how many lanes, swaths, and surfaces are imaged on the flow cell.

- SP flow cells have a total of 312 tiles.
- S1 flow cells have a total of 624 tiles.
- S2 flow cells have a total of 1408 tiles.
- S4 flow cells have a total of 3744 tiles.

Table 13 Flow Cell Tiles

Flow Cell Component	SP	S1	S2	S4	Description
Lanes	2	2	2	4	A lane is a physical channel with input and output ports.
Surfaces	1	2	2	2	The S1, S2, and S4 flow cells are imaged on two surfaces: the top and bottom. The top surface of a tile is imaged first. The SP flow cell is imaged on the bottom surface only.
Swaths per lane	2	2	4	6	A swath is a column in a flow cell lane that the camera captures as one image.
Tiles per swath	78	78	88	78	A tile is a portion of a swath and depicts an imaged area on the flow cell.
Total tiles generated	312	624	1408	3744	Lanes × surfaces × swaths × tiles per swath equals the total number of tiles.

## Tile Naming

The tile name is a five-digit number that represents the tile position on the flow cell. For example, tile name

1\_1205 indicates lane 1, top surface, swath 2, tile 5.

- The first digit is the lane number:
  - 1 or 2 for an SP, S1, or S2 flow cell.
  - 1, 2, 3, or 4 for an S4 flow cell.
- The second digit represents the surface: 1 for top or 2 for bottom.  
For the SP flow cell, the second digit is always 2 because this flow cell only has a bottom surface.
- The third digit represents the swath number:
  - 1 or 2 for an SP or S1 flow cell.
  - 1, 2, 3, or 4 for an S2 flow cell.
  - 1, 2, 3, 4, 5, or 6 for an S4 flow cell.
- The last two digits represent the tile number. The numbering starts with 01 at the outlet end of the flow cell through 88 or 78 at the inlet end.
  - 01 through 78 for an SP, S1, or S4 flow cell.
  - 01 through 88 for an S2 flow cell.

## Real-Time Analysis Workflow

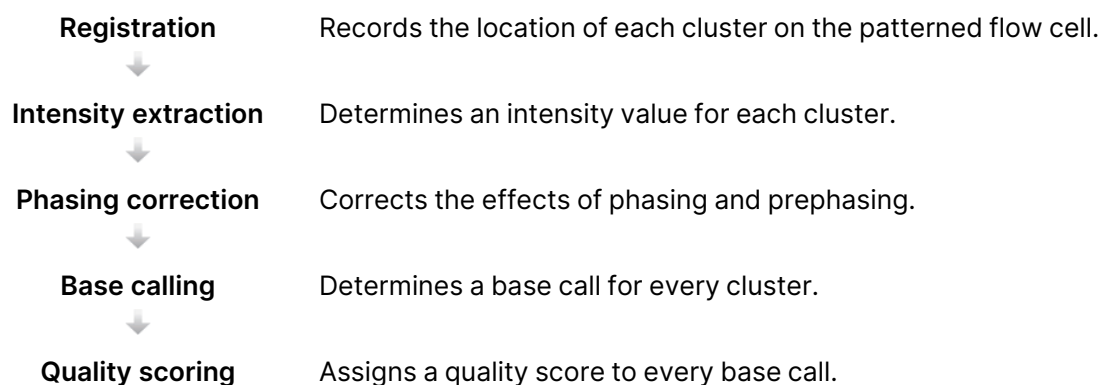

### Registration

Registration aligns an image to the hexagonal array of nanowells on the patterned flow cell. Because of the ordered arrangement of nanowells, the X and Y coordinates for each cluster in a tile are predetermined. Cluster positions are written to a cluster location (s.locs) file for each run.

If registration fails for any images in a cycle, no base calls are generated for that tile in that cycle. Use Sequencing Analysis Viewer to identify which images failed registration.

### Intensity Extraction

After registration, intensity extraction calculates an intensity value for each nanowell in a given image. If registration failed, the intensity for that tile cannot be extracted.

## Phasing Correction

During the sequencing reaction, each DNA strand in a cluster extends by one base per cycle. Phasing and prephasing occurs when a strand becomes out of phase with the current incorporation cycle.

- Phasing occurs when a base falls behind.
- Prephasing occurs when a base jumps ahead.

Figure 32 Phasing and Prephasing

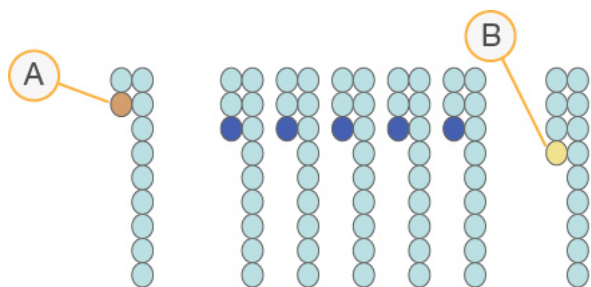

- A. Read with a base that is phasing  
B. Read with a base that is prephasing.

RTA3 corrects the effects of phasing and prephasing, which maximizes the data quality at every cycle throughout the run.

## Base Calling

Base calling determines a base (A, C, G, or T) for every cluster of a given tile at a specific cycle. The NovaSeq 6000 Sequencing System uses two-channel sequencing, which requires only two images to encode the data for four DNA bases, one from the red channel and one from the green channel.

A no call is identified as N. No calls occur when a cluster does not pass filter, registration fails, or a cluster is shifted off the image.

Intensities for each cluster are extracted from the red and green images and compared against each other, which results in four distinct populations. Each population corresponds to a base. The base calling process determines which population each cluster belongs to.



Figure 33 Visualization of Cluster Intensities

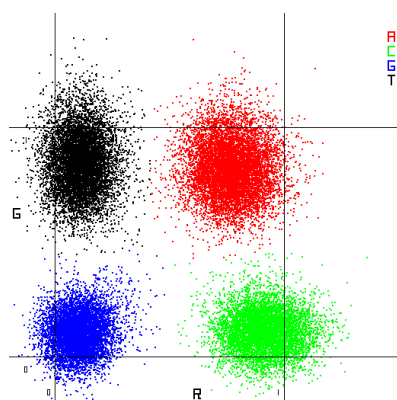

Table 14 Base Calls in 2-Channel Sequencing

Base	Red Channel	Green Channel	Result
A	1 (on)	1 (on)	Clusters that show intensity in both the red and green channels.
C	1 (on)	0 (off)	Clusters that show intensity in the red channel only.
G	0 (off)	0 (off)	Clusters that show no intensity at a known cluster location.
T	0 (off)	1 (on)	Clusters that show intensity in the green channel only.

## Clusters Passing Filter

During the run, RTA3 filters raw data to remove reads that do not meet the data quality threshold. Overlapping and low-quality clusters are removed.

For two-channel analysis, RTA3 uses a population-based system to determine the chastity (intensity purity measurement) of a base call. Clusters pass filter (PF) when no more than one base call in the first 25 cycles has a chastity below a fixed threshold. PhiX alignment is performed at cycle 26 on a subset of tiles for clusters that passed filter. Clusters that do not pass filter are not base called and not aligned.

## Quality Scores

A quality score (Q-score) is a prediction of the probability of an incorrect base call. A higher Q-score implies that a base call is higher quality and more likely to be correct. After the Q-score is determined, results are recorded in base call (\*.cbcl) files.

The Q-score succinctly communicates small error probabilities. Quality scores are represented as Q(X), where X is the score. The following table shows the relationship between a quality score and error probability.

Q-Score Q(X)	Error Probability
Q40	0.0001 (1 in 10,000)
Q30	0.001 (1 in 1000)
Q20	0.01 (1 in 100)
Q10	0.1 (1 in 10)

## Quality Scoring and Reporting

Quality scoring calculates a set of predictors for each base call, and then uses the predictor values to look up the Q-score in a quality table. Quality tables are created to provide optimally accurate quality predictions for runs generated by a specific configuration of sequencing platform and version of chemistry.

**i** | Quality scoring is based on a modified version of the Phred algorithm.

RTA3 assigns each base call one of three quality scores based on the confidence of the base call. This Q-score reporting model reduces storage space and bandwidth requirements without affecting accuracy or performance.

For more information on quality scoring, refer to *NovaSeq™ 6000 System Quality Scores and RTA3 Software (Pub.No.770-2017-010)*.

# Output Folders and Files

## Sequencing Output Folder Structure

The NVCS generates the output folder name automatically.

 **Config**—Configuration settings for the run.

 **Logs**—Log files describing operational steps, instrument analytics, and RTA3 events.

 **Data**

 **Intensities**

 **BaseCalls**

 **L00[X]**—Base call files (\*.cbcl) aggregated in one file per lane, surface, and cycle.

 s.locs—The cluster locations file for the run.

 **InterOp**—Binary files used by Sequencing Analysis Viewer.

 **Recipe**—Run-specific recipe file.

 **Thumbnail Images**—Thumbnail images for every 10<sup>th</sup> tile.

 **LIMS**—The run setup file (\*.json), if applicable.

 RTA3.cfg

 RunInfo.xml

 RunParameters.xml

 RTAComplete.txt

 CopyComplete.txt

 SampleSheet.csv—Sample sheet or other attached file, if applicable.

 SequenceComplete.txt

## Sequencing Output Files

File Type	File Description, Location, and Name
Base call files	<p>Each cluster analyzed is included in a base call file, aggregated in one file per cycle, lane, and surface. The aggregated file contains the base call and encoded quality score for every cluster. The base call files are used by BaseSpace Sequence Hub or bcl2fastq2.</p> <p>Data\Intensities\BaseCalls\L001\C1.1 L[lane]_[surface].cbcl, for example L001_1.cbcl</p>
Cluster location files	<p>For each flow cell, a binary cluster location file contains the XY coordinates for clusters in a tile. A hexagonal layout that matches the nanowell layout of the flow cell predefines the coordinates.</p> <p>Data\Intensities s_[lane].locs</p>
Filter files	<p>The filter file specifies whether a cluster passed filters. Filter files are generated at cycle 26 using 25 cycles of data. For each tile, one filter file is generated.</p> <p>Data\Intensities\BaseCalls\L001 s_[lane]_[tile].filter</p>
InterOp files	<p>Binary reporting files used for Sequencing Analysis Viewer. InterOp files are updated throughout the run.</p> <p>InterOp folder</p>
Run information file	<p>Lists the run name, number of cycles in each read, whether the read is an Index Read, and the number of swaths and tiles on the flow cell. The run info file is created at the beginning of the run.</p> <p>[Root folder],RunInfo.xml</p>
Thumbnail files	<p>When enabled, a thumbnail image for every 10 th tile in each color channel (red and green).</p> <p>Thumbnail_Images\L001\C[X.1]—Files are stored in a subfolder for each cycle. s_[lane]_[tile]_[channel].jpg—The thumbnail image includes the tile number.</p>

# Windows Security

## Password Requirements

The following table identifies the required password policies for the control computer. The software prompts for a password change at the first logon.

Table 15 Default Password Policies

Policy	Security Setting
Enforce password history	5 passwords remembered
Maximum password age	180 days
Minimum password age	0 days
Minimum password length	10 characters
Password must meet complexity requirements	Disabled
Store passwords using reversible encryption	Disabled

## Windows Firewall

The Windows firewall protects the control computer by filtering incoming traffic to remove potential threats. The firewall is enabled by default to block all inbound connections. Keep the firewall enabled and allow outbound connections. For more information on outbound connections, refer to the *NovaSeq Series Site Prep Guide (document # 1000000019360)*.

## Enhanced Mitigation Experience Toolkit

The Enhanced Mitigation Experience Toolkit (EMET) prevents the exploitation of software vulnerabilities and provides the Certificate Trust feature. The feature detects and stops attacks that use malicious certificates.

## Software Restriction Policies

Windows Software Restriction Policies (SRP) use rules to allow only specified software to run. For the NovaSeq 6000, SRP rules are based on certificates, file names and extensions, and directories.

By default, SRP is turned on to prevent unwanted software from running on the control computer. An IT representative or system administrator can add and remove rules to customize the security level. If the system is added to a domain, the local Group Policy Object (GPO) might automatically modify the rules and turn off SRP.

-  Turning off the software restriction policy prevents the protection it provides. Changing the rules overrides the default protections.

## Allowed SRP Rules

On the NovaSeq 6000 Sequencing System, SRP defaults to allowing the following rules.

### Certificates

DigitalSystems  
Illumina, Inc.  
NovaSeq

### Executable Files

Portmon.exe  
Procmon.exe  
Procmon64.exe  
Tcpview.exe

### File Extensions

\*.bin  
\*.cbcl  
\*.cfg  
\*.config  
\*.csv  
\*.dat  
\*.focus  
\*.imf1  
\*.ims  
\*.jpg  
\*.json  
\*.lnk  
\*.locs  
\*.log  
\*.manifest  
\*.sdf  
\*.tif  
\*.txt  
\*.xml

### Directories

%HKEY\_LOCAL\_MACHINE\SOFTWARE\Microsoft\Windows\CurrentVersion\ProgramFilesDir%  
%HKEY\_LOCAL\_MACHINE\SOFTWARE\Microsoft\Windows NT\CurrentVersion\SystemRoot%  
C:\CrashDumps\\*

## Directories

C:\Illumina\  
 C:\Illumina Maintenance Logs\  
 C:\LocalSymbols\  
 C:\Program Files (x86)\Chromium\Application\  
 C:\Program Files (x86)\EMET 5.5\  
 C:\Program Files (x86)\Illumina\  
 C:\Program Files (x86)\Internet Explorer\  
 C:\Program Files (x86)\LibreOffice 5\  
 C:\Program Files\Illumina\  
 C:\ProgramData\Illumina\  
 C:\ProgramData\Package Cache\  
 C:\Users\sbsuser\AppData\Local\Temp\Citrix\  
 C:\Users\sbsuser\AppData\Local\Temp\CitrixLogs\  
 C:\Users\sbsuser\Desktop\FSE turn over to customer.bat  
 D:\Illumina\

## Adding and Removing SRP Rules

Add and remove SRP rules to customize system security. Modifying the rules requires temporarily turning off SRP.

 Turning off SRP overrides the default protections.

1. Log in to the operating system.

To turn off SRP:

- a. Navigate to the directory `C:\Illumina\Security`
- b. Double-click `Disable.reg`
- c. Select **Yes** to confirm the changes.

When using the touch-screen interface, tapping and holding for about 2 seconds is equivalent to a right-click.

- d. Select **Start**, and then select **Run**.
- e. In the Open field, enter `secpol.msc`.
- f. In the Local Security Policy dialog box, expand **Software Restriction Policies**, and then select **Additional Rules**.

To add a rule:

- a. On the Action menu, select **New Path Rule**.
- b. In the Path field, enter the certificate, file name, file extension, or directory that you want to allow.
- c. In the Security level list, select **Unrestricted**.
- d. [Optional] In the Description field, enter a reason for creating the rule.

- e. Select **OK** to add the rule.

To delete a rule:

- a. Select the rule you want to delete, and then select **Delete**.
  - b. Select **Yes** to confirm the deletion.
  - c. Close the Local Security Policy dialog box.
  - d. *Immediately* reinstate SRP:
  - e. Navigate to the directory `C:\Illumina\Security`.
  - f. Double-click `Enable.reg`.
2. If SRP rules were modified for the first time, log off and then log on again for the rules to take effect.



# NovaSeq 6000Dx Research Mode Considerations

## Introduction

The NovaSeq 6000Dx Sequencing System has two separate modes of operation, *in vitro* diagnostic (IVD) mode and research use only (RUO) mode. Within RUO mode, you can create a run manually or choose a preplanned run from several sources.

Illumina Run Manager is a feature of NovaSeq 6000Dx Instrument only. For instructions on creating a planned run in Illumina Run Manager or using IVD mode, refer to the *NovaSeq 6000Dx Instrument Product Documentation (document # 200010105)*.

When in RUO manual mode, instructions in this guide are applicable to the NovaSeq 6000Dx Instrument with the following exceptions:

- Consumables compatibility
- Instrument mode indicators
- Maintenance wash procedures

## NovaSeq 6000Dx Run Planning Options

There are several options for planning a run on the NovaSeq 6000Dx Instrument.

- **Manual**—Enter run information manually. Only available when the instrument is in RUO mode. Refer to [Set Up a Sequencing Run on page 49](#).
- **LIMS**—Select a run from a LIMS server or file-based LIMS. Only available when the instrument is in RUO mode. Refer to [Run Setup Modes on page 27](#).
- **Illumina Run Manager**—Plan a run on the DRAGEN server using Illumina Run Manager. Available in either IVD or RUO mode. For more information on this method, the DRAGEN server, and Illumina Run Manager, refer to the *NovaSeq 6000Dx Instrument Product Documentation (document # 200010105)*.

## NovaSeq 6000Dx Consumables Compatibility

Performing a sequencing run on the NovaSeq 6000Dx Instrument requires a single-use NovaSeq 6000 Kit or NovaSeq 6000Dx Kit, buffer cartridge, and library tube. You can use NovaSeq 6000Dx consumables for an RUO mode run. NovaSeq 6000 consumables cannot be used for an IVD mode run.

## NovaSeq 6000Dx Instrument Mode Indicators

The NovaSeq 6000Dx Instrument features a toggle button on the home screen that can be used to switch between RUO mode and IVD mode. When the NovaSeq 6000Dx Instrument is toggled to RUO mode, use the radio buttons to select planned mode or manual mode.

The following table lists instrument mode indicators on the home screen.

Mode	Color Bar
IVD mode	Gray
RUO mode	Blue

# Index

## %

%PF 76

## A

administrator account 82  
 alignment failure 67  
 amplification 2  
 analysis 32  
 analysis methods 3  
 analysis settings 27  
 applications 1  
 automated checks 67

## B

base call files 72, 79  
 BaseSpace Enterprise 32  
 BaseSpace Sequence Hub 1, 32  
   connecting and disconnecting 53  
   support 3  
 batch code 23  
 bcl2fastq 32, 72  
 blinking icons 9  
 bubbles 46  
 buffer cartridge 52, 64  
 buffer compartment 52

## C

cameras 1, 6, 73  
 cap holders 35, 40  
 cartridges  
   stacking 17  
 catalog numbers 12  
   user-supplied consumables 19  
 CBCL files 3, 58, 76  
 CE 10, 72

Certificate Trust 80  
 chastity filter 76  
 chiller 8  
 clamps, flow cell 6  
 cluster cartridge 14  
 cluster intensities 74  
 cluster locations 72, 79  
 clustering duration 57  
 clusters passing filter 57  
 compartments 6  
 Compute Engine 10, 59, 72  
 consumables  
   laboratory-grade water 22  
   maintenance washes 61  
   packaging 23  
   unloading 59-60, 65  
 control computer 80  
 control libraries 25  
 control software 9  
 cross-contamination 8, 60  
 custom primers 2, 17, 53  
 customer support 91  
 Customization tab 25  
 cycle numbers 57

## D

data quality 76  
 data transfer 10, 59  
 default settings 27, 32  
 diagnostics 6  
 disk space 10, 67  
 dock 42, 49  
   components 18  
 documentation 2, 91  
 domain, BaseSpace Sequence Hub 32  
 DPX reagents, storing 17  
 DPX/JPX reagents, compatibility 17  
 drip tray 68

## durations

- automatic post-run wash 60
- cluster generation 57
- maintenance wash 61
- sequencing run 57

**E**

- EMET 80
- error logs 73
- errors 9, 67
  - probability 76-77
- ExAmp Master Mix 2, 46
- ExAmp reagents 14, 45
  - mixing methods 4
  - storing 17
  - thawing 42
- expiration dates 23

**F**

- FASTQ conversion 32, 72
- files
  - run-specific 67
- filter files 72, 79
- filtering clusters 76
- firewalls 80
- flow cell holder 49
- flow cell stage 6, 49
- flow cells
  - cleaning 42, 49
  - labeling 13
  - scratches 42, 49
  - specifications 13
  - storing 13, 42
- fluidics problems 68
- fluidics system 8, 62
- formamide disposal 17, 59
- four-lane flow cells 14
- freezer specifications 22

**G**

- gaskets 14, 42, 49
- gaskets, overflowing 46
- gloves, changing 35, 40, 64
- GPO 80
- green channel 75
- Group Policy Object 80

**H**

- hard drive 10, 27-28, 59
- hazardous chemicals 8, 23
- health data 27-28
- help 67
  - documentation 2
- help, technical 91
- hosting locations 32

**I**

- icons 10, 23
- icons, blinking 9
- Illumina Proactive monitoring service 27-28
- images 72
- imaging 3, 14, 72-73
- inbound connections 80
- Index Reads 53
- individually addressable lanes 4, 18
- initialization 25
- input wells 18
- instrument performance data 27-28
- instrument relocation 70
- intensity values 74
- InterOp files 9, 67, 72, 79

**J**

- JPX reagent, storing 17

**K**

- kit components 21

kit configurations 12

## L

labels, kit components 13  
 laboratory-grade water guidelines 22  
 lane numbering 18, 46  
 lanes 14, 73  
 leaks 68  
 libraries  
     storing 70  
 library tubes 17, 69  
     incardridge storage 69  
     storing 13, 70  
 light bar 6, 70  
 LIMS 1, 27  
 LIMS setup 28  
 liquids compartment 16  
 loading concentration 2  
 loading volume 2  
 log files 67, 73  
 lot numbers 23

## M

maintenance washes  
     consumables 19, 61  
     wash solutions 62  
 maintenance, preventive 61  
 manufacturer 23  
 modes 13  
 moving instruments 70

## N

nanowells 74  
 NaOCl 60, 62  
 Network Access tab 25  
 no calls 74-75  
 NovaSeq Xp dock 42, 49  
 NovaSeq Xp manifold wells, numbering 18  
 NovaSeq Xp manifolds 42  
     storing 17

NovaSeq Xp workflow 30  
 NovaSeq Xp, defined 4  
 nucleotides 75  
 number of cycles 53  
 numbering, wells 18

## O

online training 2  
 operating system 25  
 optical alignment target 6, 49  
 optics 6  
 outbound connections 80  
 output folder 27-28  
 output folder name 78  
 overflow 35, 40, 68

## P

part numbers 23  
 passing filter (PF) 76  
 password policies 80  
 patterned flow cells 1, 14  
 pausing runs 58  
 phasing and prephasing 75  
 PhiX 25  
     alignment 72  
     catalog number 19  
 Phred algorithm 77  
 pipettes 22  
 plot colors 57  
 position #30 59, 64  
 post-run activities 60  
 power 25  
 powering down 70  
 pre-run checks 67  
 preventive maintenance 61  
 privileges, administrator account 82  
 Process Management 58

## Q

Q-scores 57, 76-77

quality tables 77

## R

Read 1 70

reads, number of 13

reagent cartridges

labeling 13, 16

preparing 34, 39

storing 13, 69

unloading 51

reagent chiller 8

Real-Time Analysis 1, 9

red channel 75

refrigerator specifications 22

registration failures 74

restarting after shutdown 70

resuming runs 70

RFID 13, 67

run duration 57

run modes 27

run settings 27

run setup folder 27-28

RunInfo.xml 67, 79

runs

deleting 10

metrics 57, 72

monitoring 32, 53

pausing 58

resuming 70

staggering 58

## S

safety data sheets 8

sample sheet format 32

sample sheets 32, 53

sample tracking 17

saving library tubes 70

saving reagent cartridges 69

scanning 3

scratches, flow cells 42, 49

security 80-81

customizing 82

sensors 6, 64, 67

Sequencing Analysis Viewer 72, 74

sequencing consumables 19

sequencing cycles 57

sequencing runs

deleting 59

Sequencing screen 57

sequencing steps 2

settings

first time setup 25

Settings tab 25

single-read runs 53

sipper positions 60, 65

site prep 2, 80

sodium hypochlorite 60, 62

software suite 9

specifications 13

SRP defaults 81

stacking cartridges 17

Standard workflow 30

Standard, defined 4

status bar 6, 70

storage conditions 23

storing data 53

storing reagent kits 13, 17

suppliers 19

support bulletins 67

support pages 67

surface numbering 73

swaths 3, 14, 73

system connectivity 67

System Settings 25

## T

technical assistance 91

template generation 74

thaw racks 34, 39

thumbnails 79

tile numbering 73

tiles 3, 14, 72

turning on 25  
Tween 20 62  
two-channel sequencing 3, 75  
two-lane flow cells 14

## U

Universal Copy Service 9-10, 58  
unloading reagent cartridges 51  
USB ports 6  
used reagent disposal 8  
used reagents 8, 35, 40, 51

## W

warnings 9  
wash cartridges 61-62, 64  
wash flow cell 61  
wash solution 16  
washes  
    duration 60-61  
    frequency 61  
water baths 34, 39  
website, support 67  
well numbering 46  
white papers 77  
whitelist, SRP 81  
Windows  
    security 80-81  
wire racks 34, 39  
workflow 30

## Y

yield 57

# Technical Assistance

For technical assistance, contact Illumina Technical Support.

**Website:** [www.illumina.com](http://www.illumina.com)  
**Email:** [techsupport@illumina.com](mailto:techsupport@illumina.com)

## Illumina Technical Support Telephone Numbers

Region	Toll Free	International
Australia	+61 1800 775 688	
Austria	+43 800 006249	+43 1 9286540
Belgium	+32 800 77 160	+32 3 400 29 73
Canada	+1 800 809 4566	
China		+86 400 066 5835
Denmark	+45 80 82 01 83	+45 89 87 11 56
Finland	+358 800 918 363	+358 9 7479 0110
France	+33 8 05 10 21 93	+33 1 70 77 04 46
Germany	+49 800 101 4940	+49 89 3803 5677
Hong Kong, China	+852 800 960 230	
India	+91 8006500375	
Indonesia		0078036510048
Ireland	+353 1800 936608	+353 1 695 0506
Italy	+39 800 985513	+39 236003759
Japan	+81 0800 111 5011	
Malaysia	+60 1800 80 6789	
Netherlands	+31 800 022 2493	+31 20 713 2960
New Zealand	+64 800 451 650	
Norway	+47 800 16 836	+47 21 93 96 93
Philippines	+63 180016510798	
Singapore	1 800 5792 745	
South Korea	+82 80 234 5300	
Spain	+34 800 300 143	+34 911 899 417



Region	Toll Free	International
Sweden	+46 2 00883979	+46 8 50619671
Switzerland	+41 800 200 442	+41 56 580 00 00
Taiwan, China	+886 8 06651752	
Thailand	+66 1800 011 304	
United Kingdom	+44 800 012 6019	+44 20 7305 7197
United States	+1 800 809 4566	+1 858 202 4566
Vietnam	+84 1206 5263	

**Safety data sheets (SDSs)**—Available on the Illumina website at [support.illumina.com/sds.html](https://support.illumina.com/sds.html).

**Product documentation**—Available for download from [support.illumina.com](https://support.illumina.com).



Illumina

5200 Illumina Way

San Diego, California 92122 U.S.A.

+1.800.809.ILMN (4566)

+1.858.202.4566 (outside North America)

[techsupport@illumina.com](mailto:techsupport@illumina.com)

[www.illumina.com](http://www.illumina.com)

**For Research Use Only. Not for use in diagnostic procedures.**

© 2022 Illumina, Inc. All rights reserved.

**illumina**<sup>®</sup>