

# cBot

## System Guide

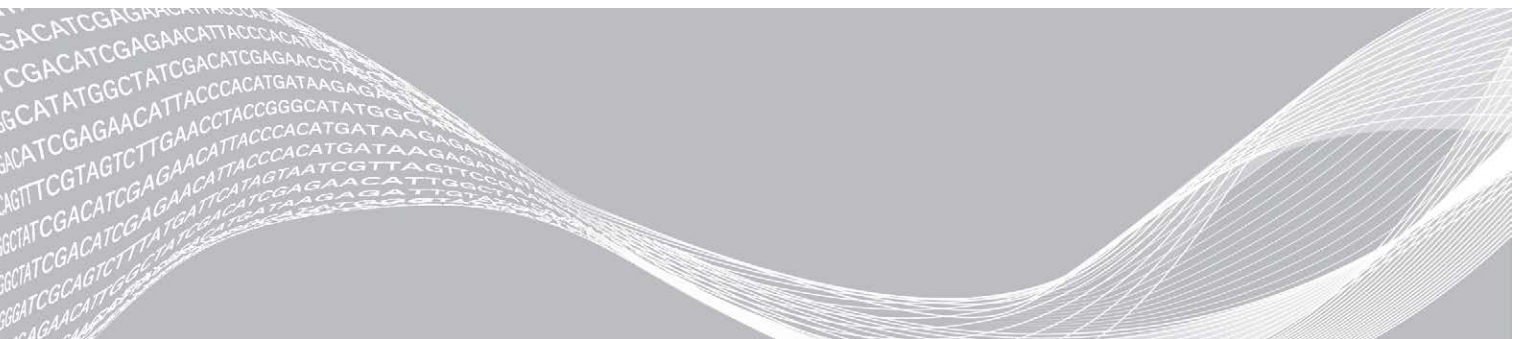

This document and its contents are proprietary to Illumina, Inc. and its affiliates ("Illumina"), and are intended solely for the contractual use of its customer in connection with the use of the product(s) described herein and for no other purpose. This document and its contents shall not be used or distributed for any other purpose and/or otherwise communicated, disclosed, or reproduced in any way whatsoever without the prior written consent of Illumina. Illumina does not convey any license under its patent, trademark, copyright, or common-law rights nor similar rights of any third parties by this document.

The instructions in this document must be strictly and explicitly followed by qualified and properly trained personnel in order to ensure the proper and safe use of the product(s) described herein. All of the contents of this document must be fully read and understood prior to using such product(s).

FAILURE TO COMPLETELY READ AND EXPLICITLY FOLLOW ALL OF THE INSTRUCTIONS CONTAINED HEREIN MAY RESULT IN DAMAGE TO THE PRODUCT(S), INJURY TO PERSONS, INCLUDING TO USERS OR OTHERS, AND DAMAGE TO OTHER PROPERTY, AND WILL VOID ANY WARRANTY APPLICABLE TO THE PRODUCT(S).

ILLUMINA DOES NOT ASSUME ANY LIABILITY ARISING OUT OF THE IMPROPER USE OF THE PRODUCT(S) DESCRIBED HEREIN (INCLUDING PARTS THEREOF OR SOFTWARE).

© 2020 Illumina, Inc. All rights reserved.

All trademarks are the property of Illumina, Inc. or their respective owners. For specific trademark information, see [www.illumina.com/company/legal.html](http://www.illumina.com/company/legal.html).

## Revision History

Document	Date	Description of Change
Document # 15006165 v05	May 2020	Updated reagent plate images.
Document # 15006165 v04	April 2019	Updated reagent plate descriptions and images.
Document # 15006165 v03	January 2019	Updated foil color from red to white for HP5 8-tube strip. Added denature and dilute information for Nextera DNA Flex libraries. Removed references to TruSeq v2 GA kits as they are no longer supported. Removed material number as this document is no longer printed.
Document # 15006165 v02	January 2016	Added PhiX and library volumes to the PhiX spike-in procedure for libraries clustered on a HiSeq 3000/4000 flow cell. Added recommendation for annual preventive maintenance service. Updated instructions for unloading run components to include flow cell storage options. Listed the <i>cBot System Configuration Guide (document # 1000000005301)</i> in Additional Resources.
Document # 15006165 v01	August 2015	Updated software descriptions to cBot software v3.0, which enables the use of the HiSeq 3000/4000 SR Cluster Kit. Added recipes for the following flow cells: HiSeq X v2.5, HiSeq 3000/4000 SR, TruSeq v3, and GAllx v2. Added the following information: <ul style="list-style-type: none"> <li>• Instructions by flow cell type for preparing clustering reagents.</li> <li>• Instruction to use HiSeq X and HiSeq 3000/4000 flow cells within 4 hours of opening.</li> <li>• Clustering duration for HiSeq 3000/4000 SR flow cells.</li> <li>• Fisher Scientific catalog # AB-0784 for 8-cap strips.</li> </ul> Updated instructions for resetting the barcode scanner to the default configuration. Moved troubleshooting information to Appendix A. Removed descriptions of software screens. Descriptions are included with clustering steps as needed.

Document	Date	Description of Change
Part # 15006165 Rev. O	February 2015	<p>Updated supported kits to include the HiSeq X Five Reagent Kit v2, single pack and 10 pack, and the HiSeq 3000/4000 PE Cluster Kit. Added names of recipes used with the HiSeq X Five v2 flow cell and the HiSeq 3000/4000 flow cell.</p> <p>Updated clustering workflow to include HiSeq X Five v2 flow cells and HiSeq 3000/4000 flow cells.</p> <p>Changed the name of the HiSeq X HD Reagent Kit v2 to HiSeq X Ten Reagent Kit v2, and changed the name of the 20-pack kit to 10-pack kit. (Change in name only; contents have not changed.)</p> <p>Removed Appendix A, which contained configuration procedures. For configuration procedures, see the <i>cBot System Site Prep Guide (document # 15053710)</i>.</p> <p>Corrected clustering duration for HiSeq v4 and HiSeq X flow cells from approximately 2.5 hours to approximately 3 hours.</p>
Part # 15006165 Rev. N	November 2014	<p>Added the HiSeq Rapid Duo cBot Sample Loading Kit, which supports clustering for the HiSeq Rapid Run v2 mode on the HiSeq 2500 and HiSeq 1500.</p> <p>Added a type of rapid flow cell, HiSeq Rapid v2 flow cell, including compatible recipes.</p> <p>Added clustering duration for rapid flow cells.</p> <p>Added the HiSeq X HD Reagent Kit v2, single pack and 20 pack.</p> <p>Added information about cBot reagent plate orientation for HiSeq X kit.</p> <p>Added note stating that it is not possible to confirm reagent delivery from the reagent plate provided in the HiSeq X HD Reagent Kit v2.</p>
Part # 15006165 Rev. M	September 2014	<p>Removed the HiSeq Multi-Primer Rehybridization Kit v4 from available cBot kits. The HiSeq Multi-Primer Rehybridization Kit v4 is used on the HiSeq only.</p> <p>Removed HiSeq X from the list of workflows that require primers in the Primers position. The 8-tube strip containing the ExAmp reagents and library in the HiSeq X workflow is loaded in the Templates position.</p> <p>Added name of recipe used with a rapid flow cell and the TruSeq Rapid Duo Sample Loading Kit to cBot Recipes and Flow Cell Types.</p> <p>Corrected frequency on periodic maintenance schedule for the monthly maintenance wash.</p> <p>Corrected documentation titles in Additional Resources.</p> <p>Updated URL for Safety Data Sheets (SDS) to <a href="http://support.illumina.com/sds.html">support.illumina.com/sds.html</a>.</p>
Part # 15006165 Rev. L	April 2014	<p>Updated to cBot software v2.0, which enables the use of HiSeq v4 and HiSeq X kits.</p> <p>Added workflow information for using HiSeq v4 flow cells and HiSeq X flow cells.</p> <p>Removed the procedure to denature libraries and prepare a PhiX control. See <i>Denaturing and Diluting Libraries for the HiSeq and GALX (part # 15050107)</i>.</p> <p>Removed reagent preparation instructions. For reagent preparation instructions including information about sequencing primers, see the kit documentation.</p> <p>Removed the site prep and installation information. See the <i>cBot Site Prep and Installation Guide (part # 15053710)</i>.</p>

Document	Date	Description of Change
Part # 15006165 Rev. K	October 2012	Added information for template hybridization on a TruSeq Rapid flow cell.
Part # 15006165 Rev. J	July 2012	Added sequencing primers requirements for dual-indexed TruSeq HT libraries.
Part # 15006165 Rev. H	April 2012	Updated information for sequencing dual-indexed libraries. Added the following procedures: <ul style="list-style-type: none"> <li>• Reagent preparation instructions, including instructions for preparing HP10</li> <li>• Primer rehybridization procedure</li> </ul>
Part # 15006165 Rev. G	October 2011	Added new section titled <i>Dual-Indexed Sequencing Modifications</i> .
Part # 15006165 Rev. F	June 2011	Updated procedure for preparing template DNA to include instructions for higher concentrations, and added note about high NaOH concentration.
Part # 15006165 Rev. E	April 2011	Updated software descriptions to cBot software v1.4. Added the following information: <ul style="list-style-type: none"> <li>• TruSeq Cluster Kit v3 and catalog number</li> <li>• Description of keyed corner as visual orientation when loading HiSeq Flow Cell v3</li> <li>• New section titled <i>Version Compatibility of Run Components</i> that lists compatible software and recipe versions for various flow cell types</li> </ul> Updated recommended DNA template storage to a concentration of 2 nM, and adjusted protocol for preparing DNA using a 2 nM template.
Part # 15006165 Rev. D	October 2010	Updated software descriptions to cBot software v1.3. Added the following information: <ul style="list-style-type: none"> <li>• Recommended cluster densities based on version of analysis software</li> <li>• Instructions for upgrading the software</li> <li>• Instructions for recovering a run</li> </ul>
Part # 15006165 Rev. C	May 2010	Updated software descriptions to cBot software v1.1. Added flow cell storage recommendation. Increased water wash volume to 12 ml and DECON to 10 ml.
Part # 15006165 Rev. B	March 2010	Corrected centrifuge instructions for thawing the reagent plate. Added the following information: <ul style="list-style-type: none"> <li>• Instructions for loading the HiSeq flow cell, and associated templates and primers</li> <li>• Instructions for installing the adapter plate</li> <li>• HiSeq Cluster Generation Kit catalog numbers and kit descriptions</li> <li>• Instructions for setting local date and time using the Time tab</li> <li>• Monthly maintenance wash procedure</li> </ul>
Part # 15006165 Rev. A	October 2009	Initial release.

# Table of Contents

<b>Chapter 1 Overview</b> .....	<b>7</b>
Introduction .....	7
Additional Resources .....	7
cBot Components .....	8
Illumina Consumables .....	11
cBot Reagent Plates .....	12
<b>Chapter 2 Getting Started</b> .....	<b>14</b>
Start the cBot .....	14
Version Compatibility of Run Components .....	14
User-Supplied Consumables .....	15
<b>Chapter 3 Preparing Reagents</b> .....	<b>16</b>
Introduction .....	16
HiSeq X Flow Cell .....	16
HiSeq 3000/4000 Flow Cell .....	20
HiSeq High Output Flow Cell .....	23
HiSeq Rapid Flow Cell .....	24
<b>Chapter 4 Clustering</b> .....	<b>25</b>
Introduction .....	25
Clustering Workflow .....	25
Perform a Pre-Run Wash .....	26
Select a Protocol .....	27
Load Consumables .....	27
Perform a Pre-Run Check .....	30
Monitor the Run .....	31
Unload Run Components .....	32
Perform a Post-Run Wash .....	33
Confirm Reagent Delivery (Optional) .....	33
<b>Chapter 5 Maintenance</b> .....	<b>35</b>
Perform Periodic Maintenance .....	35
Perform a Monthly Maintenance Wash .....	35
Change the Adapter Plate .....	36
Upgrade the Software .....	37
Upgrade Recipes .....	38
Shut Down the cBot .....	39
<b>Appendix A Troubleshooting</b> .....	<b>41</b>
Pause or Abort a Run .....	41
Troubleshoot Flow Check Failure .....	41
Troubleshoot Run Problems .....	43
Reset the Barcode Scanner .....	44
Edit Protocols .....	45
<b>Index</b> .....	<b>47</b>
<b>Technical Assistance</b> .....	<b>50</b>

# Chapter 1 Overview

Introduction .....	7
Additional Resources .....	7
cBot Components .....	8
Illumina Consumables .....	11
cBot Reagent Plates .....	12

## Introduction

The cBot uses amplification to create hundreds of millions of single-molecule DNA templates simultaneously. The cBot software dispenses reagents and controls reaction times, flow rates, and temperatures. Setup and operation are performed on-instrument from the cBot software interface using the touch screen monitor. An on-instrument barcode reader records the reagents and flow cell used for each experiment.

Figure 1 cBot

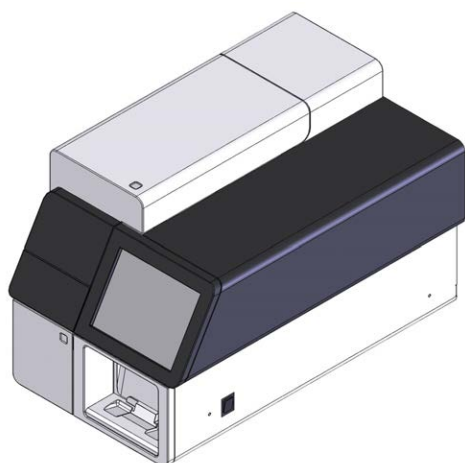

Several cluster kits are available for use on the cBot. Use a kit that is compatible with the sequencing instrument and type of sequencing run to be performed. For a list of available kits, see *Illumina Consumables* on page 11.

## Additional Resources

The following documentation is available for download from the Illumina website.

Resource	Description
<i>cBot System Site Prep Guide (document # 15053710)</i>	Provides specifications for laboratory space, electrical requirements, and environmental considerations and instructions for configuring the instrument.
<i>cBot Safety and Compliance Booklet (part # 15012615)</i>	Provides information about instrument labeling, compliance certifications, and safety considerations.
<i>HiSeq Systems Denature and Dilute Libraries Guide (document # 15050107)</i>	Provides instructions for denaturing and diluting prepared libraries before sequencing, and preparing a PhiX control. This step applies to most library types and flow cells.

Visit the cBot support page on the Illumina website for access to documentation, software downloads, online training, and frequently asked questions.

## cBot Components

The cBot uses sensors to detect the presence of run components and provides prompts when a component is missing or installed incorrectly. The thermal stage and reagent stage are located under the cBot lid. For safety, the software prompts you to close the lid before proceeding with the run.

**Figure 2** cBot Components

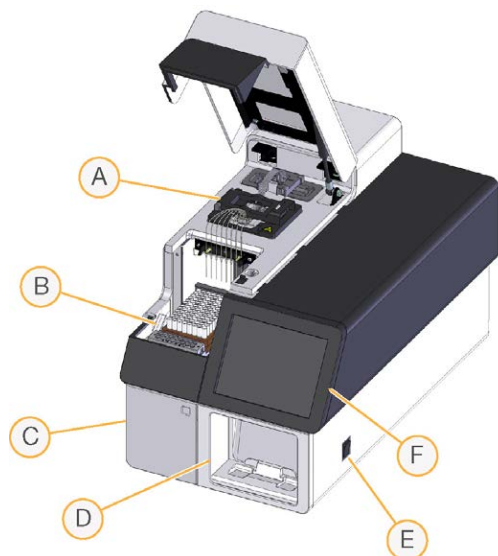

- A **Thermal stage**—Holds the flow cell and controls the flow cell temperature throughout the run.
- B **Reagent stage**—Holds the cBot reagent plate, library templates, and specialty primers.
- C **Waste bottle compartment**—Holds a sensor-controlled waste bottle that collects spent reagents.
- D **Barcode scanner**—Records the unique ID of the reagent plate and flow cell used with each run.
- E **Power switch**—Turns on the instrument. The start button, located to the left of the waste bottle compartment, starts the instrument software.
- F **Touch screen monitor**—Provides on-instrument run setup and visual status of the cluster generation process.

## Thermal Stage

The thermal stage holds the flow cell and manifold, which is seated over the flow cell. The flow cell clamp locks the flow cell and manifold into place.



### WARNING

Do not touch the aluminum thermal block on the thermal stage. The heater poses a serious burn hazard during operation. For more safety information, see the *cBot Safety and Compliance Booklet* (part # 15012615).

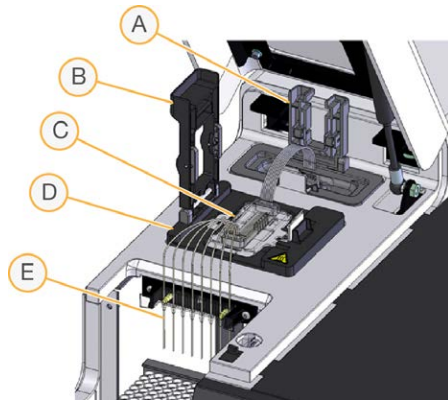

**Figure 3** Thermal Stage

- A Output clamp
- B Flow cell clamp
- C Flow cell and manifold
- D Thermal stage
- E Sipper comb

The manifold is a single-use component that delivers reagents from the reagent plate to the flow cell. The sippers on the sipper comb pierce the foil-sealed reagent tubes seated in the reagent plate. The outlet end of the manifold transfers waste to the waste container. The outlet clamp locks the outlet end of the manifold in place.

## Flow Cell Adapter Plates

The cBot performs cluster generation on HiSeq flow cells. When switching flow cell types, change the adapter plate on the flow cell stage. For details, see [Change the Adapter Plate on page 36](#).

## Reagent Stage

The reagent stage holds the cBot reagent plate. The reagent plate lever locks the plate into position. Two 8-tube strip holders in front of the reagent plate hold prepared library templates and additional primers.

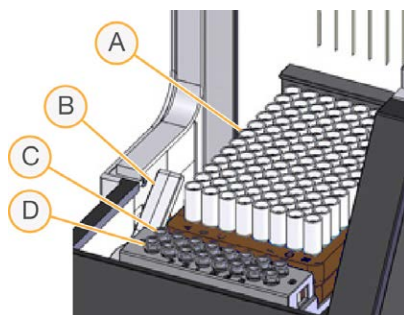
**Figure 4** cBot Reagent Stage

- A cBot reagent plate
- B Reagent plate lever
- C Template row
- D Primer row















## cBot Software

The cBot software interface provides prompts for setting up the instrument and monitoring clustering progress. During a cluster generation run, the following screens are used: Start screen, Run Setup screens, and the Run Status screen.

Use the software interface to configure input requirements, wash preferences, email notifications, and remote monitoring.

### Sensor Status Icons

Displayed at the bottom of the screen, sensor status icons indicate whether a component is properly installed and ready for the run.

Icon	Indication
	GAllx flow cell adapter plate installed.*
	HiSeq flow cell adapter plate installed.
	Flow cell adapter plate type unknown.
	Instrument lid is open.
	Instrument lid is closed.
	Waste bottle is present and ready for use.
	Waste bottle is full.
	Waste bottle is missing.
	Coolant is flowing and coolant level is good.
	Warning: Coolant is flowing, but coolant level is low.
	Error: Coolant is not flowing, but coolant level is good.
	Error: Coolant is not flowing and coolant level is low.
	Manifold is loaded and sipper comb is secure.
	Manifold is missing or sipper comb is not secure.

\*This option is visible but is no longer supported.

## Configuration

Use the software interface to configure system settings, input requirements, and wash preferences. Using a network connection, you can enable remote monitoring, email alerts, and LIMS support. Configuration settings can be modified as needed before the start of each run.

For configuration instructions, see the *cBot System Configuration Guide* (document # 1000000005301).

## Illumina Consumables

cBot reagents are provided in a reagent plate that loads directly onto the instrument after thawing. cBot reagent plates are provided in the following Illumina kits.

Descriptions of kit contents and other kit documentation are available on [the cBot support page](#) on the Illumina website. For reagent preparation instructions, see [Preparing Reagents on page 16](#).

### Cluster Kits for the HiSeq

Each kit contains a HiSeq flow cell, a flow cell-specific manifold, and the required reagents for clustering the flow cell on the cBot.

Kit Name	Kit Catalog #
HiSeq 3000/4000 SR Cluster Kit	Catalog # GD-410-1001
HiSeq 3000/4000 PE Cluster Kit	Catalog # PE-410-1001
HiSeq SR Cluster Kit v4	Catalog # GD-401-4001
HiSeq PE Cluster Kit v4	Catalog # PE-401-4001
TruSeq SR Cluster Kit v3 - HS	Catalog # GD-401-3001
TruSeq PE Cluster Kit v3 - HS	Catalog # PE-401-3001
HiSeq Rapid Duo cBot Sample Loading Kit	Catalog # CT-403-2001

### Cluster Kits for the HiSeq X

Each kit contains multiple HiSeq X flow cells, flow cell-specific manifolds, and the required reagents for clustering each flow cell on the cBot. Single-pack kits contain consumables for clustering two flow cells and 10-pack kits contain consumables for clustering 20 flow cells.

Kit Name	Kit Catalog #
HiSeq X Ten Reagent Kit v2.5	Catalog # FC-501-2501
HiSeq X Ten Reagent Kit v2.5 (10 pack)	Catalog # FC-501-2521
HiSeq X Five Reagent Kit v2.5	Catalog # FC-502-2501
HiSeq X Five Reagent Kit v2.5 (10 pack)	Catalog # FC-502-2102

### Rehybridization Kits

Use a cBot rehybridization kit to perform Read 1 primer rehybridization for run recovery or after extended flow cell storage.

Kit Name	Catalog #
HiSeq X cBot Multi-Primer Rehybridization Kit v2	Catalog # GD-305-2001
HiSeq 3000/4000 cBot Multi-Primer Rehybridization Kit	Catalog # GD-310-1001
TruSeq v2 cBot Multi-Primer Rehybridization Kit	Catalog # GD-304-2001
HiSeq® Multi-Primer Rehybridization Kit v4	Catalog # GD-403-4001

For more information, see the rehybridization guide for your flow cell:

- ▶ HiSeq X—*Read 1 Primer Rehybridization on a HiSeq X Flow Cell (document # 15053711)*
- ▶ HiSeq 3000/4000—*Read 1 Primer Rehybridization on a HiSeq 3000/4000 Flow Cell (document # 15058794)*
- ▶ TruSeq v3—*Read 1 Primer Rehybridization on a TruSeq v3 Flow Cell (document # 15018149)*

## Read 1 Sequencing Primer for Nextera Libraries

The Read 1 sequencing primer (HP6) provided in the following kits is not compatible with Nextera libraries:

- ▶ TruSeq Cluster Kit v3 - HS

If you are sequencing Nextera libraries, use the Read 1 sequencing primer (HP10), regardless of the type of run you are performing. HP10 is provided in the TruSeq Dual Index Sequencing Primer Box.



Kit Name	Catalog #
TruSeq Dual Index Sequencing Primer Box, Single Read	Catalog # FC-121-1003
TruSeq Dual Index Sequencing Primer Box, Paired End	Catalog # PE-121-1003

All other cBot kits include HP10, which is compatible with TruSeq and Nextera libraries.

## cBot Reagent Plates

The configuration of the reagent plate differs between kit types, including the number of rows that contain reagent.

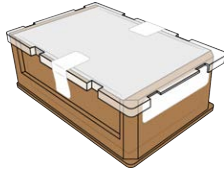
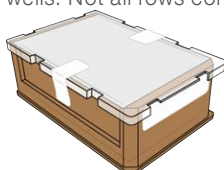
Each 8-tube strip is labeled with the reagent name followed by a number. The number indicates the row that it occupies on the reagent plate. If an 8-tube strip becomes dislodged, use the row number on the label to return the tube strip to the appropriate position.

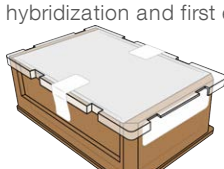
Flow Cell Type	Reagent Plate Description
HiSeq X and HiSeq 3000/4000	Contains 12 rows with eight deep wells each. Each reagent occupies a full row of eight wells. Not all rows contain reagent.
	
HiSeq High Output (HiSeq v4)	Contains 12 rows with eight deep wells each. Each reagent occupies a full row of eight wells. Not all rows contain reagent. Rows nine through 12 are empty.
	
HiSeq High Output (TruSeq v3)	Contains 11 rows of foil-sealed 8-tube strips filled with cluster generation reagents. Row 12 is empty.
	
HiSeq Rapid	Contains 12 rows with eight deep wells each. The first three rows are filled with template hybridization and first extension reagents. Rows four through 12 are empty.
	



**WARNING**

Except for the HiSeq rapid reagent plate, these sets of reagents contain formamide, an aliphatic amide that is a probable reproductive toxin. Personal injury can occur through inhalation, ingestion, skin contact, and eye contact. Dispose of containers and any unused contents in accordance with the governmental safety standards for your region. For more information, see the SDS for this kit at [support.illumina.com/sds.html](http://support.illumina.com/sds.html).

# Chapter 2 Getting Started

Start the cBot .....	14
Version Compatibility of Run Components .....	14
User-Supplied Consumables .....	15

## Start the cBot

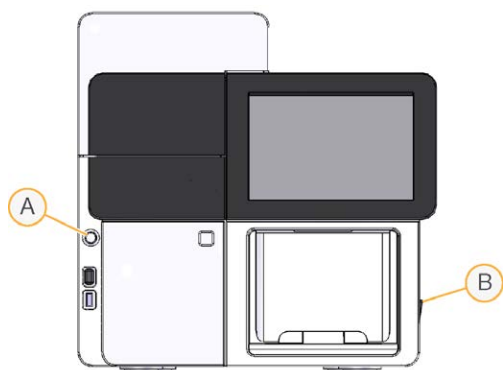

- A Start button
- B Power switch

- 1 Switch the power switch on the right side of the instrument to the ON position.
- 2 Press the start button to the left of the waste bottle compartment to start the software.  
When the start-up routine is complete, the Start screen appears.

## Version Compatibility of Run Components

For best performance and results, always use compatible versions of cBot software and kits.

Kit Version	Recipe Version	Software Version
HiSeq 3000/4000 Cluster Kit	Version 1.0 recipes	cBot v3.0.46, or later (SR kit) cBot v2.0.34, or later (PE kit)
HiSeq X Ten Reagent Kit v2.5	Version 2.0 recipes	cBot v2.0.29, or later
HiSeq X Five Reagent Kit v2.5	Version 2.0 recipes	cBot v2.0.29, or later
HiSeq Cluster Kit v4	Version 9.0 recipes	cBot v2.0.16, or later
HiSeq Rapid Duo cBot Sample Loading Kit	Version R recipes	cBot v1.5, or later
TruSeq Dual Index Sequencing Primer Box	Version 8.0 recipes (HiSeq) Version 7.0 recipes (GA)	cBot v1.4.36, or later
TruSeq Cluster Kit v3 - HS	Version 8.0 recipes	cBot v1.4, or later
TruSeq Cluster Kit v2 - GA*	Version 7.0 recipes	cBot v1.3, or later

\*This option is visible but is no longer supported.

## cBot Recipes and Flow Cell Types

Flow Cell	Primary Recipe Name
HiSeq 3000/4000 Patterned Flow Cell	HiSeq_3000_4000_SR_HD_Exclusion_Amp_v1.0 HiSeq_3000_4000_HD_Exclusion_Amp_v1.0
HiSeq X Ten v2.5 Patterned Flow Cell	HiSeq_X_HD_Exclusion_Amp_v2.0
HiSeq X Five v2.5 Patterned Flow Cell	HiSeq_X_HD_Exclusion_Amp_v2.0
HiSeq v4 Flow Cell	SR_HiSeq_Cluster_Kit_v4_cBot_recipe_v9.0 PE_HiSeq_Cluster_Kit_v4_cBot_recipe_v9.0
TruSeq v3 Flow Cell	SR_Amp_Lin_Block_TubeStripHyb_v8.0 PE_Amp_Lin_Block_TubeStripHyb_v8.0 SR_Amp_Lin_Block_Hyb_v8.0 PE_Amp_Lin_Block_Hyb_v8.0
HiSeq Rapid v2 Flow Cell	RR_TemplateHyb_FirstExt_vR <sup>1</sup>

<sup>1</sup> Used only with the Rapid Duo kits.

## User-Supplied Consumables

The following user-supplied consumables are used for preparation of clustering reagents provided in the HiSeq X<sup>®</sup> and HiSeq<sup>®</sup> 3000/4000 kits.

The HiSeq X and HiSeq 3000/4000 kits introduce a denaturation step before clustering on the cBot. Using these kits, libraries are denatured in the 8-tube strip before adding the ExAmp reaction mix.

Component	Supplier	Purpose
1 N NaOH	General lab supplier	Library denaturation
8-cap strips, flat	Fisher Scientific, catalog # AB-0784	Capping the 8-tube strips when not loaded onto the cBot
8-tube strips, 0.2 ml	Fisher Scientific, catalog # AB-0264	ExAmp reaction and library mix on the cBot
Laboratory-grade water	Millipore or General lab supplier	Library denaturation
Microcentrifuge tubes, 1.5 ml	VWR, catalog #20170-038*	Preparing ExAmp Reaction master mix

\*Or equivalent

# Chapter 3 Preparing Reagents

Introduction .....	16
HiSeq X Flow Cell .....	16
HiSeq 3000/4000 Flow Cell .....	20
HiSeq High Output Flow Cell .....	23
HiSeq Rapid Flow Cell .....	24

## Introduction

Reagent preparation instructions depend on your reagent kit. The instructions are organized by flow cell type and include HiSeq X, HiSeq 3000/4000, HiSeq high output, and HiSeq rapid.

After preparation, clustering reagents are ready to be loaded onto the cBot when prompted by the software.

## Best Practices

- ▶ Wear a fresh pair of gloves when preparing clustering reagents.
- ▶ Do not remove the protective clear plastic lid on the reagent plate until you are ready to load reagents onto the cBot. Never puncture the foil seals.
- ▶ Hold reagent plates that contain 8-tube strips by the plate base to avoid dislodging reagent tubes. Make sure that the tubes are securely seated in the reagent plate before and after vortexing or inverting. Loose tubes can damage the cBot manifold.
- ▶ For cluster generation on a HiSeq X or HiSeq 3000/4000 flow cell, **always** prepare freshly diluted NaOH for denaturing libraries. This step is essential to the denaturation process. To prevent small pipetting errors, prepare at least 1 ml freshly diluted 0.1 N NaOH.

## HiSeq X Flow Cell

Prepare the HiSeq X patterned flow cell, then prepare clustering reagents. To prepare clustering reagents, thaw the cBot reagent plate and prepare the ExAmp master mix.

If you are using the 10-pack kit, prepare four flow cells and thaw four cBot reagent plates. Make sure that four cBot instruments are available. Reagents cannot be stored after preparation.

## About Reagents

- ▶ ExAmp reagents are viscous, especially EPX2 and EPX3. Aspirate and dispense reagents slowly to ensure accurate pipetting.
- ▶ EPX3 does not move when inverted due to viscosity.
- ▶ **Never vortex** ExAmp reagents, and do not refreeze after thawing.
- ▶ The ExAmp master mix can be cloudy, which is normal. If the solution separates into a cloudy portion and a transparent portion, slowly pipette to mix.

## Prepare the Flow Cell

- 1 Remove a new flow cell package from 2°C to 8°C storage.
- 2 Set aside the flow cell package at room temperature for at least 30 minutes.





**NOTE**

If the foil packaging is intact, the flow cell can remain at room temperature up to 12 hours. You can return the packaged flow cell to 2°C to 8°C storage for later use one time only. Avoid repeated cooling and warming of the flow cell.

- 3 Put on a new pair of powder-free gloves.
- 4 Peel open the foil package from the end with the angled seal. Use the flow cell within 4 hours of opening the foil package.

**Figure 5** Open Flow Cell Package



- 5 Remove the clamshell package from the foil packaging.

**Figure 6** Remove From Foil Packaging

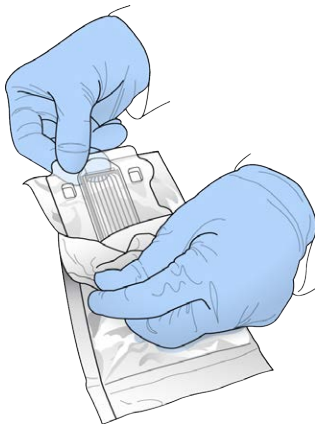

- 6 Open the clamshell package and remove the flow cell.

**Figure 7** Remove Flow Cell From Clamshell Package

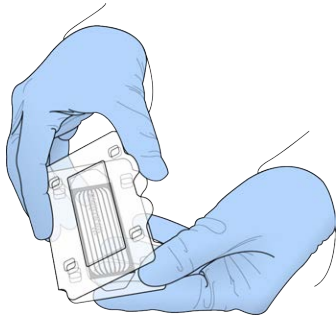

- 7 Clean the flow cell with a lint-free alcohol wipe.
- 8 Dry with a lint-free tissue.
- 9 Set aside at room temperature.

## Thaw the cBot Reagent Plate

- 1 Remove the cBot reagent plate from  $-25^{\circ}\text{C}$  to  $-15^{\circ}\text{C}$  storage.
- 2 Thaw in a room temperature water bath ( $19^{\circ}\text{C}$  to  $25^{\circ}\text{C}$ ) for a minimum of 60 minutes. Reagent plates must be used the same day they are thawed.

## Thaw EPX1, EPX2, EPX3, and RSB

- 1 Remove one tube each of the following reagents from  $-25^{\circ}\text{C}$  to  $-15^{\circ}\text{C}$  storage.
  - ▶ **Single-pack kit**—EPX1, EPX2, EPX3, and RSB. Each tube contains enough reagent for one flow cell.
  - ▶ **10-pack kit**—EPX1M, EPX2M, EPX3M, and RSB. Each tube contains enough reagent for four flow cells.
- 2 Thaw at room temperature for 10 minutes.
- 3 Set aside on ice.

## Prepare a Fresh Dilution of NaOH

- 1 Combine the following volumes in a microcentrifuge tube:
  - ▶ Laboratory-grade water ( $900\ \mu\text{l}$ )
  - ▶ Stock 1 N NaOH ( $100\ \mu\text{l}$ )
 These volumes result in 1 ml of 0.1 N NaOH.
- 2 Invert to mix.

## Denature Libraries and Add Optional PhiX Control

The library loading concentration depends on the libraries to be sequenced. The following instructions apply to either TruSeq Nano DNA (350 bp) or TruSeq DNA PCR-Free (350 bp) libraries. Dilute to a concentration appropriate for the library type.

- ▶ A DNA loading concentration that is too high causes reduced %PF.
- ▶ A DNA loading concentration that is too low causes reduced %PF and a high percentage of duplicates that negatively affect depth of coverage.

Repeat the following instructions for each flow cell to be sequenced.

- 1 Dilute the library or pooled libraries to the appropriate concentration:
  - ▶ **TruSeq Nano DNA libraries**—Dilute to 2–3 nM in RSB.
  - ▶ **TruSeq DNA PCR-Free libraries**—Dilute to 1–2 nM in RSB.
- 2 **[Optional]** Spike in 1% *nondenatured* Illumina PhiX control to *nondenatured* libraries:
  - ▶ **TruSeq Nano DNA libraries**—Add 0.5 µl 2–3 nM PhiX to 50 µl 2–3 nM library.
  - ▶ **TruSeq DNA PCR-Free libraries**—Add 0.5 µl 1–2 nM PhiX to 50 µl 1–2 nM library.
- 3 Label the tubes of an 8-tube strip #1 through #8.
- 4 Denature the library in the 8-tube strip as follows.
  - a Add 5 µl *nondenatured* library to the bottom of each well.
  - b Add 5 µl freshly diluted 0.1 N NaOH. Slowly pipette to mix.
  - c Incubate at room temperature for 8 minutes.
  - d Add 5 µl 200 mM Tris-HCl pH 8.0. Slowly pipette to mix.
- 5 Set aside on ice until you are ready to add the ExAmp master mix.



#### CAUTION

Prepare and add the ExAmp master mix within **30 minutes**.

## Prepare the cBot Reagent Plate

- 1 Invert to mix.
- 2 Vortex to dislodge trapped air bubbles.
- 3 Tap on a hard surface to collect reagent droplets. Alternatively, pulse centrifuge.
- 4 Set aside on ice.

## Prepare the ExAmp Reaction

Prepare the ExAmp reaction master mix immediately before use. Follow the appropriate instructions for the number of flow cells you are preparing.

### ExAmp Reaction for 1 Flow Cell (Single-Pack Kit)

- 1 Invert EPX1 and EPX2 to mix.
- 2 Briefly centrifuge EPX1, EPX2, and EPX3.
- 3 Prepare the ExAmp master mix in a 1.5 ml tube as follows.
  - a Add 210 µl EPX1.
  - b Add 30 µl EPX2. Slowly pipette to mix.
  - c Add 110 µl EPX3. Slowly pipette to mix.
  - d Make sure that the bottom of the tube is free of bubbles.
- 4 Add 35 µl master mix to the bottom of each well of the 8-tube strip.
  - ▶ Slowly pipette to mix.
  - ▶ Change tips between samples.
- 5 Briefly centrifuge, and then set aside on ice for up to 15 minutes, until you are ready to load the cBot.

## ExAmp Reaction for 4 Flow Cells (10-Pack Kit)

- 1 Invert EPX1M and EPX2M to mix.
- 2 Briefly centrifuge EPX1M, EPX2M, and EPX3M.
- 3 Prepare the ExAmp master mix in a 1.5 ml tube as follows.
  - a Add 756  $\mu$ l EPX1M.
  - b Add 108  $\mu$ l EPX2M. Slowly pipette to mix.
  - c Add 396  $\mu$ l EPX3M. Slowly pipette to mix.
  - d Make sure that the bottom of the tube is free of bubbles.
- 4 Add 35  $\mu$ l of the master mix into the bottom of each well of the 8-tube strips.
  - ▶ Slowly pipette to mix.
  - ▶ Change tips between samples.
- 5 Briefly centrifuge the 8-tube strip, and then set aside on ice for up to 15 minutes, until you are ready to load the cBot.

## HiSeq 3000/4000 Flow Cell

Prepare the HiSeq 3000/4000 patterned flow cell, then prepare clustering reagents. To prepare clustering reagents, thaw the cBot reagent plate and prepare the ExAmp reaction master mix.

### About Reagents

- ▶ ExAmp reagents are viscous, especially EPX2 and EPX3. Aspirate and dispense reagents slowly to ensure accurate pipetting.
- ▶ EPX3 does not move when inverted due to viscosity.
- ▶ **Never vortex** ExAmp reagents, and do not refreeze after thawing.
- ▶ The ExAmp master mix can be cloudy, which is normal. If the solution separates into a cloudy portion and a transparent portion, slowly pipette to mix.

### Prepare the Flow Cell

- 1 Remove a new flow cell package from 2°C to 8°C storage.
- 2 Set aside the flow cell package at room temperature for at least 30 minutes.



#### NOTE

If the foil packaging is intact, the flow cell can remain at room temperature up to 12 hours. You can return the packaged flow cell to 2°C to 8°C storage for later use one time only. Avoid repeated cooling and warming of the flow cell.

- 3 Put on a new pair of powder-free gloves.

- 4 Peel open the foil package from the end with the angled seal. Use the flow cell within 4 hours of opening the foil package.

**Figure 8** Open Flow Cell Package



- 5 Remove the clamshell package from the foil packaging.

**Figure 9** Remove From Foil Packaging



- 6 Open the clamshell package and remove the flow cell.

**Figure 10** Remove Flow Cell From Clamshell Package

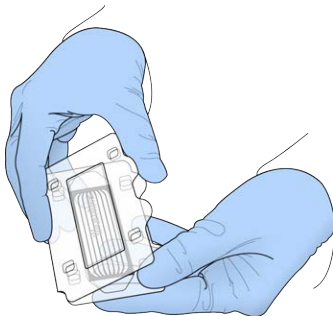

- 7 Clean the flow cell with a lint-free alcohol wipe.
- 8 Dry with a lint-free tissue.
- 9 Set aside at room temperature.

## Thaw the cBot Reagent Plate

- 1 Remove the cBot reagent plate from -25°C to -15°C storage.
- 2 Thaw in a room temperature water bath (19°C to 25°C) for a minimum of 60 minutes. Reagent plates must be used the same day they are thawed.

## Thaw EPX1, EPX2, EPX3, and RSB

- 1 Remove EPX1, EPX2, EPX3, and RSB from -25°C to -15°C storage.
- 2 Thaw at room temperature for 10 minutes.
- 3 Set aside on ice.

## Prepare a Fresh Dilution of NaOH

- 1 Combine the following volumes in a microcentrifuge tube:
  - ▶ Laboratory-grade water (900 µl)
  - ▶ Stock 1 N NaOH (100 µl)
 These volumes result in 1 ml of 0.1 N NaOH.
- 2 Invert to mix.

## Denature Libraries and Add Optional PhiX Control

The library loading concentration depends on the libraries to be sequenced. The following instructions apply to supported Illumina libraries and assume an insert size typical for the associated library type. Make sure that you dilute to a concentration appropriate for the library type.

- ▶ A DNA loading concentration that is too high causes reduced %PF.
  - ▶ A DNA loading concentration that is too low causes reduced %PF and a high percentage of duplicates that negatively affect depth of coverage.
- 1 Dilute the library or pooled libraries to the appropriate concentration.

Library Type	Dilution
TruSeq DNA PCR-Free	Dilute to 1–2 nM in RSB.
Nextera DNA Flex	Dilute to 2–3 nM in RSB.
TruSeq Nano DNA	Dilute to 2–3 nM in RSB.
Nextera Rapid Capture Exome	
TruSeq Stranded Total RNA	
TruSeq Stranded mRNA	

- 2 **[Optional]** Spike-in 1% *nondenatured* Illumina PhiX control to *nondenatured* libraries.

Library Type	Spike-In
TruSeq DNA PCR-Free	Add 5 µl 100–200 pM PhiX to 45 µl 1–2 nM library.
Nextera DNA Flex	Dilute to 2–3 nM in RSB.
TruSeq Nano DNA	Add 5 µl 200–300 pM PhiX to 45 µl 2–3 nM library.
Nextera Rapid Capture Exome	
TruSeq Stranded Total RNA	
TruSeq Stranded mRNA	

- 3 Label a new 8-tube strip #1 through #8.
- 4 Denature the library in the 8-tube strip as follows.
  - a Add 5  $\mu$ l *nondenatured* library into the bottom of each well.
  - b Add 5  $\mu$ l freshly diluted 0.1 N NaOH. Slowly pipette to mix.
  - c Incubate at room temperature for 8 minutes.
  - d Add 5  $\mu$ l 200 mM Tris-HCl pH 8.0. Slowly pipette to mix.
- 5 Set aside on ice for up to 30 minutes, until you are ready to add the ExAmp master mix.

## Prepare the cBot Reagent Plate

- 1 Invert to mix.
- 2 Vortex to dislodge trapped air bubbles.
- 3 Tap on a hard surface to collect reagent droplets. Alternatively, pulse centrifuge.
- 4 Set aside on ice.

## Prepare the ExAmp Reaction

Prepare the ExAmp reaction master mix immediately before use.

- 1 Invert EPX1 and EPX2 to mix.
- 2 Briefly centrifuge EPX1, EPX2, and EPX3.
- 3 Prepare the ExAmp master mix in a 1.5 ml tube as follows.
  - a Add 210  $\mu$ l EPX1.
  - b Add 30  $\mu$ l EPX2. Slowly pipette to mix.
  - c Add 110  $\mu$ l EPX3. Slowly pipette to mix.  
Make sure that the bottom of the tube is free of bubbles.
- 4 Add 35  $\mu$ l master mix to the bottom of each well of the 8-tube strip.
  - ▶ Slowly pipette to mix.
  - ▶ Change tips between samples.
- 5 Cap the tubes and briefly centrifuge.
- 6 Set aside on ice for up to 15 minutes, until you are ready to load the cBot.

## HiSeq High Output Flow Cell

To prepare reagents, thaw and inspect the reagent plate. The reagent plate takes approximately 60 minutes to thaw using a room temperature water bath. Alternatively, you can thaw reagents at 2°C to 8°C overnight, not to exceed 16 hours.



### NOTE

When vortexing or inverting the cBot reagent plate, keep a hand on top of the plate.

## Thaw the cBot Reagent Plate

- 1 Remove the cBot reagent plate from -25°C to -15°C storage.
- 2 Thaw in a room temperature water bath (19°C to 25°C) for a minimum of 60 minutes.

Reagent plates must be used the same day they are thawed.

## Prepare the cBot Reagent Plate

- 1 Invert to mix.
- 2 Vortex to dislodge trapped air bubbles.
- 3 Tap on a hard surface to collect reagent droplets. Alternatively, pulse centrifuge.
- 4 **[For TruSeq v3 reagents]** Make sure that the tubes are free of air bubbles, securely seated, and ordered as numbered.
- 5 Promptly proceed to setting up the cBot.
- 6 If you are sequencing Nextera libraries on a TruSeq v3 flow cell, proceed to *Prepare HP10 (TruSeq v3)* before setting up the cBot.

## Prepare HP10 (TruSeq v3)

Prepare HP10 for use on the cBot only when using Nextera libraries on a TruSeq v3 flow cell. HP10 is also compatible with other Illumina library types.

- 1 Remove HP10 from -25°C to -15°C storage.
- 2 Thaw in a beaker of room temperature deionized water for 20 minutes.
- 3 Add 150 µl HP10 to each tube of an 8-tube strip.
- 4 Set aside on ice.
- 5 Promptly proceed to setting up the cBot.

## HiSeq Rapid Flow Cell

To prepare reagents, thaw and inspect the reagent plate. The reagent plate takes approximately 60 minutes to thaw using a room temperature water bath. Alternatively, you can thaw reagents at 2°C to 8°C overnight, not to exceed 16 hours.



### NOTE

When vortexing or inverting the cBot reagent plate, keep a hand on top of the plate.

## Thaw the cBot Reagent Plate

- 1 Remove the cBot reagent plate from -25°C to -15°C storage.
- 2 Thaw in a room temperature water bath (19°C to 25°C) for a minimum of 60 minutes. Reagent plates must be used the same day they are thawed.

## Prepare the cBot Reagent Plate

- 1 Invert to mix.
- 2 Vortex to dislodge trapped air bubbles.
- 3 Tap on a hard surface to collect reagent droplets. Alternatively, pulse centrifuge.
- 4 Promptly proceed to setting up the cBot.



# Chapter 4 Clustering

Introduction .....	25
Clustering Workflow .....	25
Perform a Pre-Run Wash .....	26
Select a Protocol .....	27
Load Consumables .....	27
Perform a Pre-Run Check .....	30
Monitor the Run .....	31
Unload Run Components .....	32
Perform a Post-Run Wash .....	33
Confirm Reagent Delivery (Optional) .....	33

## Introduction

All clustering steps are performed on the cBot except for preparing libraries for sequencing and preparing the cBot reagent plate. Clustering steps for a rapid flow cell consist only of template hybridization and first extension. The remaining steps are performed on the sequencing instrument.

Setting up the cBot for cluster generation includes the steps to select a protocol and then load consumables. Scan required input, such as reagent ID and flow cell ID, using the barcode scanner, or select the keyboard icon and enter the ID manually. Manual input and system input are shown on the screen.

## Library Prep

Before setting up the cBot for cluster generation, prepare libraries for sequencing. The process differs depending on library type and flow cell type.

- ▶ Most libraries on TruSeq flow cells and HiSeq flow cells require a denaturation and dilution step. For more information, see *HiSeq Systems Denature and Dilute Libraries Guide (document # 15050107)*.
- ▶ The denaturation protocol differs for HiSeq X and HiSeq 3000/4000 patterned flow cells. Denature libraries for use with these flow cell types **only** as described in the reagent preparation instructions for your flow cell type. For more information, see *Preparing Reagents on page 16*.

## Clustering Workflow

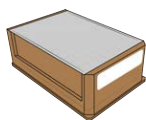

Prepare the reagent plate and flow cell. See *Preparing Reagents on page 16*.

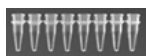

Prepare libraries for sequencing and load libraries into an 8-tube strip.



Perform a pre-run wash.



Select a protocol, scan and load consumables, and load tube strips containing prepared libraries.

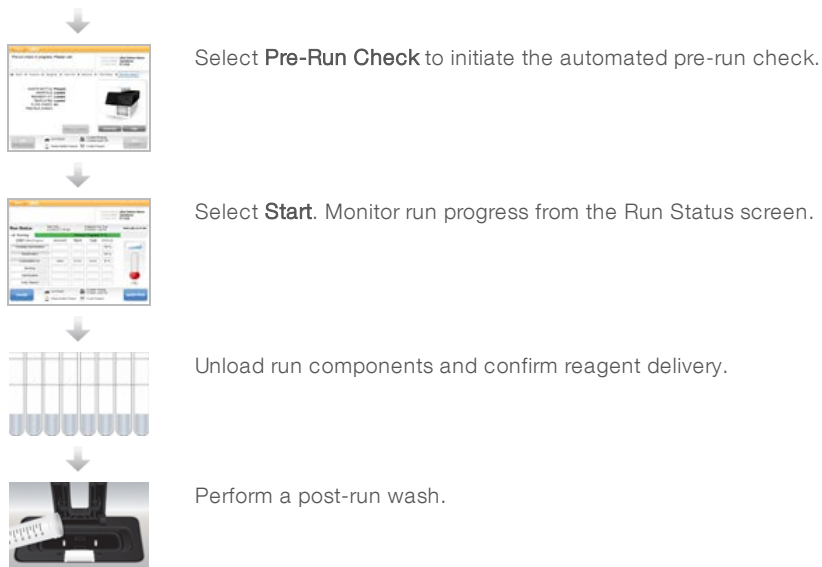

## Perform a Pre-Run Wash

A wash is recommended before clustering on the cBot.

- 1 Select **User Name**.
- 2 Using the onscreen keyboard, type your name and then select **Enter**.
- 3 Select **Start**.
- 4 If the **Manifold removed** checkbox is not selected on the Wash screen, remove the manifold.
- 5 Raise the instrument lid by lifting from the top-right corner.
- 6 Fill the wash reservoir with about 12 ml deionized water.
- 7 Close the instrument lid.
- 8 Select the **Reservoir filled with water** checkbox.
- 9 Select **Wash**.
- 10 After the wash is finished, blot excess water from the wash reservoir with a low-lint tissue.

**Figure 11** Dry the Wash Reservoir

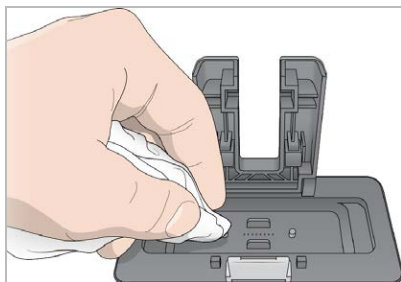

- 11 Select the **Wash reservoir dry** checkbox.
- 12 Select **Next**.

## Select a Protocol

- 1 Select **Experiment Name**.
- 2 Using the onscreen keyboard, type your experiment name and then select **Enter**.
- 3 Select the appropriate recipe for your experiment from the list of protocols.  
Scroll through to see all available protocols.
- 4 Select **Next**.

## Load Consumables

The software guides you through the steps to load the cBot reagent plate, flow cell, cBot manifold, and the 8-tube strip containing prepared libraries. Depending on the clustering protocol selected, the software prompts you to load an 8-tube strip of additional primers.

### Load the Reagent Plate

- 1 Remove the clear plastic lid from the cBot reagent plate.
- 2 Select **Scan Reagent ID** to activate the barcode scanner.
- 3 Raise the instrument lid by lifting from the top-right corner.
- 4 **[For TruSeq v3 reagents]** Remove the white foil seal as follows.
  - a Hold each end of the tube strip in row 10 and peel the white foil from the 8-tube strip. Discard the foil appropriately.
  - b Select the checkbox to indicate that the seal is removed.
- 5 Pull the reagent plate lever toward you and place the reagent plate onto the reagent stage:
  - ▶ **HiSeq High Output (TruSeq v3)**—Position with row 1 directly behind the tube strip holders. The beveled corner of the plate is positioned in the front-right corner.
  - ▶ **All reagent plates except HiSeq High Output (TruSeq v3)**—Position with the barcode label facing toward the back of the instrument. The beveled corners of the plate are positioned directly behind the tube strip holders.

**Figure 12** Position the Reagent Plate



- 6 Release the lever to secure the reagent plate.
- 7 Select the checkbox to indicate that the reagent plate is loaded, and then select **Next**.

## Load the Flow Cell

- 1 Lift the flow cell clamp.
- 2 Wash the adapter plate on the thermal stage with a small amount of deionized water.
- 3 Dry with a lint-free cleaning tissue.
- 4 Remove the flow cell from storage:
  - ▶ **All flow cells except HiSeq X and HiSeq 3000/4000**—Remove the flow cell from the storage tube using plastic forceps. Rinse the flow cell with deionized water and gently dry with a lens cleaning tissue. Save the tube and buffer for later storage.
  - ▶ **HiSeq X and HiSeq 3000/4000 flow cells**—The patterned flow cell is ready to use after flow cell preparation.
- 5 Select **Scan Flow Cell ID** to activate the barcode scanner.
- 6 Scan the flow cell ID by holding the labeled flow cell package or tube close to the scanner tray with the barcode positioned toward the instrument.
- 7 Position the flow cell on the thermal stage with flow cell port holes facing *up*. Lane 1 is on the right side with the keyed corner.
- 8 Select the checkbox to indicate that the flow cell is loaded, and then select **Next**.

## Load the Manifold

Use the manifold from the same cluster kit as the flow cell.

- 1 Inspect the sippers on the sipper comb for damage. Make sure that the black rubber gaskets are evenly seated.
- 2 Position the manifold over the flow cell with the sipper comb pointing toward the front of the cBot.
- 3 Align the manifold with the guide pins on the thermal stage and seat the manifold over the flow cell. Seat evenly to form a tight seal.
- 4 Select the **Manifold seated over flow cell** checkbox.
- 5 Close the flow cell clamp to secure the manifold.

**Figure 13** Close the Flow Cell Clamp

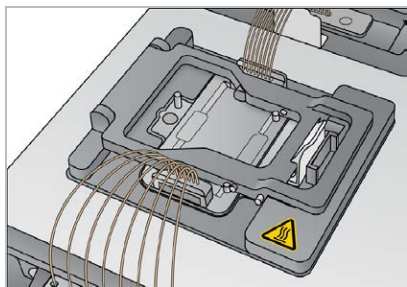

- 6 Select the **Flow cell clamp closed** checkbox.
- 7 Connect the outlet end of the manifold to the outlet port in the wash reservoir. Make sure that the outlet is evenly seated.

**Figure 14** Secure Outlet End

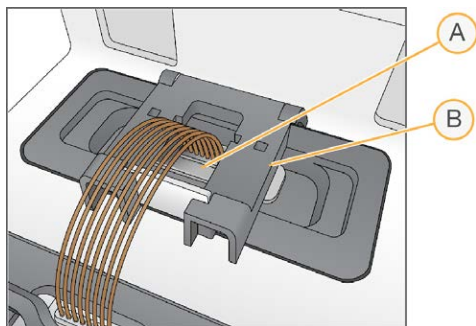

- A Outlet port
- B Output clamp

- 8 Snap the outlet clamp closed to secure the outlet end of the manifold.
- 9 Select the **Outlet clamp closed** checkbox.
- 10 Align the sipper comb with the two metal guide pins on the front of the thermal stage.

**Figure 15** Secure the Sipper Comb

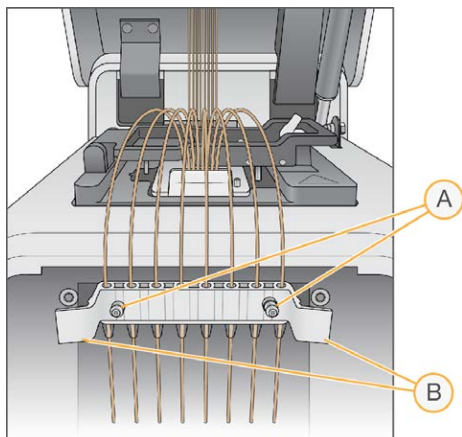

- A Metal guide pins
- B Plastic tabs

- 11 Snap the sipper comb into place using the plastic tabs on either side of the comb. Make sure that the sippers are straight and perpendicular to the reagent plate.
- 12 Select the **Sipper comb in place** checkbox, and then select **Next**.

## Load Templates

- 1 Select **Enter Template Name**.
- 2 Using the onscreen keyboard, type the template ID and then select **Enter**.
- 3 Load the 8-tube strip containing prepared libraries into the template row.
- 4 Select the checkbox to indicate that templates are loaded.

- If you are using additional primers, proceed to *Load Primers*. Otherwise, close the cBot lid and select **Next** to proceed to *Perform a Pre-Run Check* on page 30.

## Load Primers

The Load Primers screen appears for workflows that allow custom primers or require additional primers. Sequencing Nextera libraries on a TruSeq v3 flow cell requires that you load an 8-tube strip containing HP10.

- Select **Enter Primer Name**.
- Using the onscreen keyboard, type the primer name and then select **Enter**.
- Load the 8-tube strip containing primers into the primer row.  
Make sure that the order of numbered tubes aligns with the lane orientation of the flow cell.  
Tubes are numbered right to left.

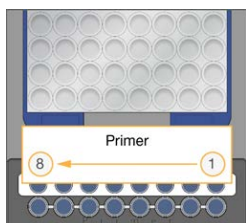

HiSeq X, HiSeq 3000/4000, HiSeq v4,  
and TruSeq v3 (HiSeq)

- Select the checkbox to indicate that primers are loaded.
- Close the instrument lid.
- Select **Next**.

## Perform a Pre-Run Check

The pre-run check reads the instrument sensors to detect the correct installation of run components and then performs a flow check using bubble sensors to detect air in the tubes. The pre-run check takes approximately 3 minutes.

- After successful completion of the pre-run check, select **Start**.  
The Run Status screen opens and the run begins.

## Run Component Errors

If the pre-run check fails due to errors related to run components, perform the following steps:

- Check any run component with an indicated error to make sure that it is present and loaded correctly.
- Select **Rerun Check** to repeat the sensor check.
- If the check continues to fail, select **Cancel Run** to end the run and set up a new one.

## Flow Check Failure

Flow check failure might be the result of an improperly loaded flow cell, a faulty manifold, or a clog in the lines. Before bypassing the flow check, see *Troubleshoot Flow Check Failure* on page 41.

## Monitor the Run

- Use the Run Status screen to monitor the run in progress.  
The Run Status screen provides the run status and the following details:
  - ▶ Start date and time, end date and time, and time remaining
  - ▶ Cluster generation protocol steps with status bar for each step
  - ▶ Reagent currently in use
  - ▶ Current temperature (°C)
  - ▶ Status of the command in the current step

Figure 16 Run Status Screen

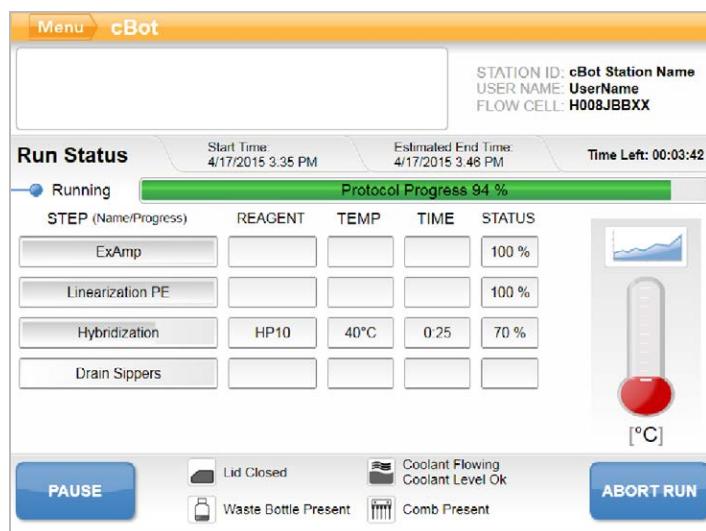

- Wait for the run to complete:
  - ▶ HiSeq v4, HiSeq 3000/4000 PE, or HiSeq X—Allow approximately 3 hours.
  - ▶ HiSeq 3000/4000 SR—Allow approximately 4 hours.
  - ▶ HiSeq Rapid v2—Allow approximately 1 hour.
  - ▶ TruSeq v3—Allow approximately 5 hours.
- After the run is complete, you can leave the flow cell on the instrument overnight. Otherwise, proceed to [Unload Run Components](#).  
The instrument holds the flow cell at 20°C.

## Run Data Report

The run data report provides a summary of the run in progress. It lists the following information:

- ▶ Protocol name
- ▶ Flow cell ID
- ▶ Reagent ID
- ▶ Template name
- ▶ Start time and finish time

At the end of the run, the run data report automatically opens to signal that the run is complete.

- To view the report during the run, select **Menu | Run Data**.

## Unload Run Components

- 1 When the run is complete, select **Unload** to proceed.

Figure 17 Run Complete, Unload Components

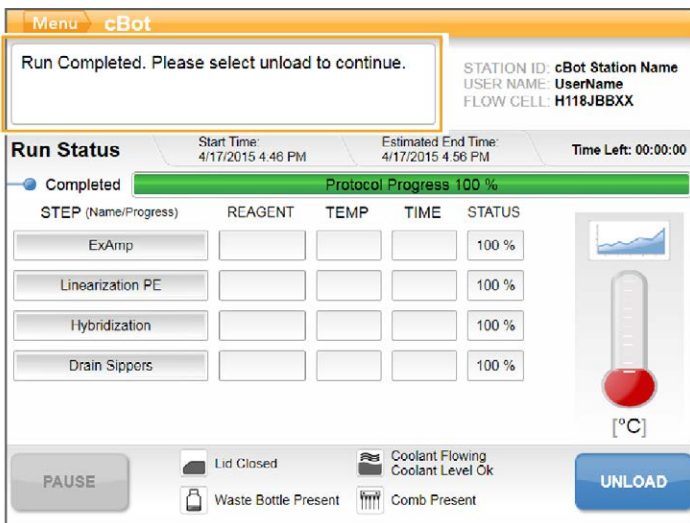

- 2 Raise the instrument lid.
- 3 Release the outlet clamp securing the outlet end of the manifold.
- 4 Disconnect the outlet end of the manifold from the outlet port in the wash reservoir.
- 5 Remove the sipper comb from the metal guide pins using the plastic tabs on either side of the sipper comb.
- 6 Release the flow cell clamp.
- 7 Remove the manifold.  
Make sure that the flow cell remains on the thermal stage.
- 8 Lift the flow cell from the thermal stage.
- 9 Store the flow cell as appropriate:
  - ▶ **TruSeq v3 and HiSeq v4 flow cells**—Store in storage buffer in the flow cell tube at 2°C to 8°C. The flow cell is stable after primer hybridization up to 10 days when properly stored in the flow cell tube.
  - ▶ **HiSeq Rapid v2 flow cells**—Perform the sequencing run on the same day as library loading.
  - ▶ **HiSeq X and HiSeq 3000/4000 flow cells**—Store in storage buffer up to 48 hours at 2°C to 8°C.
- 10 Pull the reagent plate lever toward you to release the reagent plate.
- 11 Remove the reagent plate from the reagent stage.



### WARNING

This set of reagents contains potentially hazardous chemicals. Personal injury can occur through inhalation, ingestion, skin contact, and eye contact. Wear protective equipment, including eye protection, gloves, and laboratory coat appropriate for risk of exposure. Handle used reagents as chemical waste and discard in accordance with applicable regional, national, and local laws and regulations. For additional environmental, health, and safety information, see the SDS at [support.illumina.com/sds.html](http://support.illumina.com/sds.html).



- 12 Remove the 8-tube strip containing libraries.
- 13 Remove the 8-tube strip containing additional primers, if applicable.
- 14 Select the checkbox to indicate that you have unloaded the reagents, templates, and primers.
- 15 Choose a wash option:
  - ▶ Select **Wash** to proceed to the post-run wash.
  - ▶ Select **Exit** to bypass the post-run wash, if that option is available.

## Perform a Post-Run Wash

- 1 Wash the plate on the thermal stage with deionized water to remove any salts.
- 2 Dry with a lint-free cleaning tissue.
- 3 Fill the wash reservoir with approximately 12 ml deionized water and close the instrument lid.
- 4 Select the checkbox to indicate that water is present, and then select **Wash**.
- 5 When the wash is complete, blot any excess water remaining in the wash reservoir. Avoid the outlet ports to prevent fibers from entering the holes.
- 6 Select the checkbox to indicate that the wash reservoir is dry, and then select **Exit**. The Start screen opens and the cBot is ready for another run.

## Confirm Reagent Delivery (Optional)

You can confirm delivery of individual reagents from the HiSeq High Output (TruSeq v3) reagent plate.

- 1 Inspect the foil-sealed tops of each tube strip to make sure that each seal was pierced.
- 2 Release each tube strip from the base of the reagent plate as follows.
  - a Grasp the reagent plate firmly, with finger tips under the base.
  - b Gently press upward on the center tubes of the tube strip.
- 3 Inspect each tube to confirm that a similar volume remains in each tube. Small differences are normal.

**Figure 18** Example of Successful Reagent Delivery (8-Lane Flow Cell)

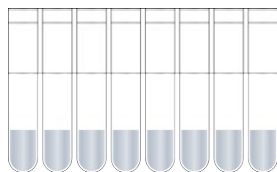

**Figure 19** Example of Successful Reagent Delivery (2-Lane Flow Cell)

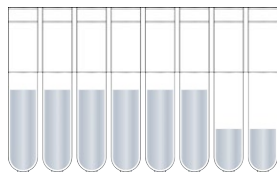

- 4 If reagent delivery was not successful and the foil seals on the reagent tubes are pierced, contact Illumina Technical Support.

- 5 Inspect the 8-tube strip containing library template.
- 6 If you used additional primers with your run, inspect the 8-tube strip containing primers.

# Chapter 5 Maintenance

Perform Periodic Maintenance .....	35
Perform a Monthly Maintenance Wash .....	35
Change the Adapter Plate .....	36
Upgrade the Software .....	37
Upgrade Recipes .....	38
Shut Down the cBot .....	39

## Perform Periodic Maintenance

Perform the basic maintenance steps described in this section to ensure optimal performance.

Maintenance	Frequency	Description
Instrument wash	Between each run and if the instrument is idle for more than a day.	Always perform an instrument wash after each run to clear salts and enzymes from the instrument hardware and to prevent clogs. If the instrument has been idle for more than 24 hours, a pre-run wash is recommended. For more information, see <a href="#">Perform a Pre-Run Wash on page 26</a> .
Empty waste bottle	Between each run.	To make sure that your run is not interrupted, empty the waste bottle between runs.
Clean surfaces	One time per week.	Use deionized water and a lint-free cleaning tissue to clean the surface of the thermal stage and the reagent stage. Clean the surface of the template and primer tube strip holders.
Clean barcode scanner window	One time per week.	Use deionized water and a lint-free cleaning tissue to clean the barcode scanner window.
Maintenance Wash	One time per month.	Use 5% DECON (or 100 mM NaOH) to remove traces of reagents from internal cBot components and inhibit the growth of microorganisms. For more information, see <a href="#">Perform a Monthly Maintenance Wash on page 35</a> .
Check coolant level	Every 3 months.	Make sure that the green coolant is visible through the coolant window on the rear panel of the instrument. If necessary, use a mirror to view the coolant window. If the coolant is low, use a wide coin or standard screwdriver to remove the coolant reservoir cap, and fill the reservoir to just below the reservoir cap. Use only Illumina coolant (part # 1003709). If you need additional coolant, contact your Illumina FAS or FSE.

## Preventive Maintenance

Illumina recommends that you schedule a preventive maintenance service each year. If you are not under a service contract, contact your Territory Account Manager or Illumina Technical Support to arrange for a billable preventive maintenance service.

## Perform a Monthly Maintenance Wash

Perform a monthly maintenance wash using 5% DECON to remove traces of reagents from internal cBot components and inhibit microbial growth. If DECON is not available, substitute 100 mM NaOH.

The maintenance wash requires approximately 10 minutes of hands-on time and consists of four wash steps: a water wash, a DECON or NaOH wash, and two more water washes.

## Water Wash

- 1 Confirm that all run components are removed.

- From the Start screen, select **Menu** and then **Manual Commands** to open the Manual Commands screen.
- Select **Commands** to open the Commands tab.
- Fill the wash reservoir with approximately 12 ml deionized water.
- Select **Wash**.
- After the wash is complete, blot excess water from the wash reservoir with a low-lint tissue. Avoid the outlet ports to prevent fibers from entering the holes.

## DECON (or NaOH) Wash

- Fill the wash reservoir with 10 ml 5% DECON or 100 mM NaOH.
- Select **Wash**.
- After the wash is complete, put on a new pair of gloves.
- Blot the 5% DECON remaining in the wash reservoir with a low-lint tissue. Avoid the outlet ports.



### CAUTION

DECON is highly alkaline.

- Immediately** proceed to the water wash to prevent DECON from drying and clogging the wash reservoir holes.

## Water Wash (First Rinse)

- Fill the wash reservoir with approximately 12 ml deionized water.
- Select **Wash**.
- After the wash is complete, blot water remaining in the wash reservoir with a low-lint tissue. Avoid the outlet ports.

## Water Wash (Final Rinse)

- Fill the wash reservoir with approximately 12 ml deionized water.
- Select **Wash**.
- After the wash is finished, blot water remaining in the wash reservoir with a low-lint tissue. Avoid the outlet ports.
- Close the instrument lid.
- Empty the waste bottle.  
Your cBot is ready for the next cluster generation run.

## Change the Adapter Plate

You can use a HiSeq flow cell on the cBot. Each flow cell type requires that a specific adapter plate is installed. Icons on the Start screen indicate which adapter plate is installed.



### NOTE

The cBot is shipped with the HiSeq adapter plate installed.

- Open the instrument lid by gently lifting from the top-right corner.

- 2 Lift the flow cell clamp.
- 3 Loosen the 2 captive Phillips head screws securing the adapter plate.

**Figure 20** Flow Cell Adapter Plate

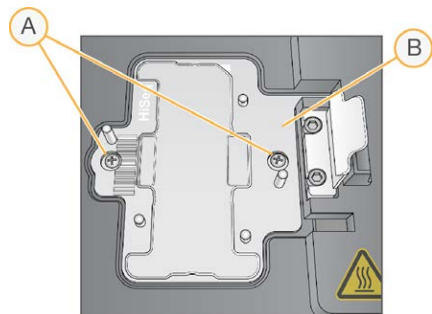

- A Captive screws
- B Adapter plate

- 4 Lift the existing adapter plate from the thermal stage and set aside.
- 5 If salts are present on the thermal stage, wipe with a lint-free cleaning tissue slightly moistened with water.
- 6 Position the new adapter plate on the thermal stage. Align the sensor arm with the corresponding slot on the right side of the thermal stage.

**Figure 21** Sensor Arm Location

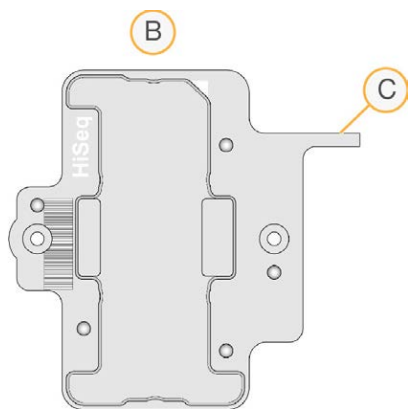

- A HiSeq adapter plate
- B Adapter plate sensor arm

- 7 Tighten the 2 screws to secure the adapter plate.  
For optimal heat transfer, make sure that the adapter plate is sitting flat and the screws are tightened evenly.
- 8 Wipe the installed adapter plate with a lint-free cleaning tissue moistened with water. Dry with a clean tissue.

## Upgrade the Software

Using cBot software v1.3, or later, you can upgrade instrument software using a USB flash drive.

- 1 Insert the USB flash drive containing the new software version installer (for example, cBotSetupX86\_1.3.1.0.exe) into either of the USB ports on the front of the instrument.  
The installer must reside in the root directory of the USB flash drive, not in a folder.



**CAUTION**

Leave the USB drive in the USB slot during the upgrade process. Do not interact with the instrument during the upgrade.

- 2 Select **Menu** in the upper-left corner of the Start screen, and then select **Configure**.

**Figure 22** Start Screen Menu

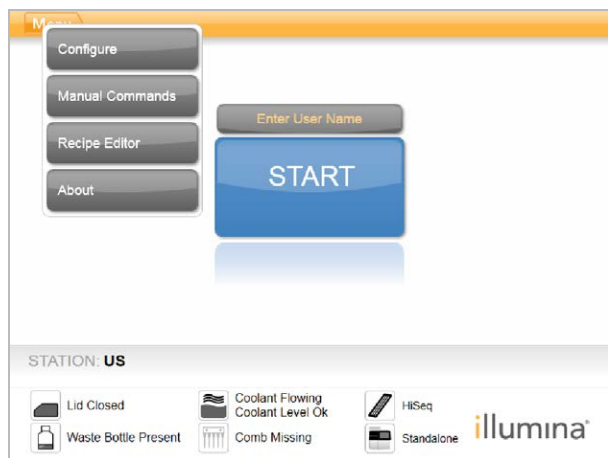

- 3 Use the onscreen keyboard to type the default password, **admin**, and then select **Enter**.
- 4 Select **Menu**, and then select **Upgrade**.
- 5 A dialog box opens with a message about the software version:

Message	Action
The software installer version is greater than the version currently installed on the cBot	Select <b>OK</b> to proceed with the installation of the newer version.
cBot cannot find a valid software installer	You can either insert a valid cBot upgrade and select <b>OK</b> to try again, or <b>Cancel</b> to abort the upgrade.
The software installer version is equal or lower than the version currently installed on the cBot	Select <b>Cancel</b> to abort the upgrade, or <b>OK</b> to proceed with installation of a previous version.

- 6 When the restart is complete and the login screen opens, you can remove the USB flash drive.

## Upgrade Recipes

Upgrade recipe versions independently of software upgrades using a USB flash drive containing the recipe installer.

- 1 Insert the USB flash drive containing the new recipe installer into either of the USB ports on the front of the instrument.  
The installer must reside in the root directory of the USB flash drive, not in a folder.
- 2 Select **Menu** in the upper-left corner of the Start screen, and then select **Configure**.

Figure 23 Start Screen Menu



- 3 Use the onscreen keyboard to type the default password, **admin**, and then select **Enter**.
- 4 Select **Menu**, and then select **Upgrade Recipes**.  
When the upgrade is complete, the cBot restarts automatically. The restart process takes about 10 minutes.

**CAUTION**

Leave the USB drive in the USB slot during the upgrade process. Do not interact with the instrument during the upgrade.

- 5 When the restart is complete and the login screen opens, remove the USB flash drive.

## Shut Down the cBot

The cBot is designed to run in an idle state from the Start screen, so shutting it down between runs is not necessary.

- 1 Select **Menu** in the upper-left corner of the Start screen, and then select **Configure**.

Figure 24 Start Screen Menu

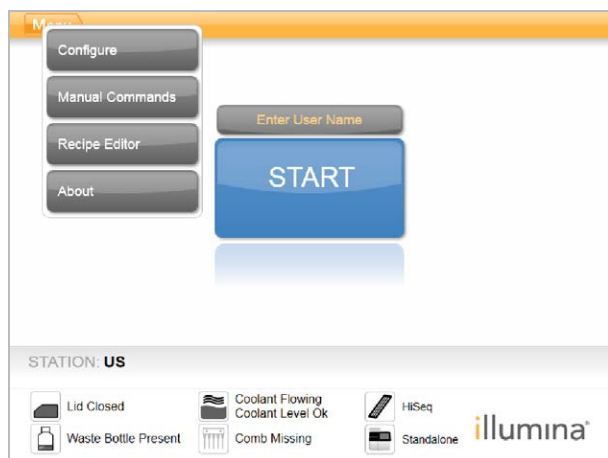

- 2 Use the onscreen keyboard to type the default password, **admin**, and then select **Enter**.

- From the Configuration screen, select **Menu** and then select **Shut Down Station**. The cBot software shuts down.

Figure 25 Shut Down Station

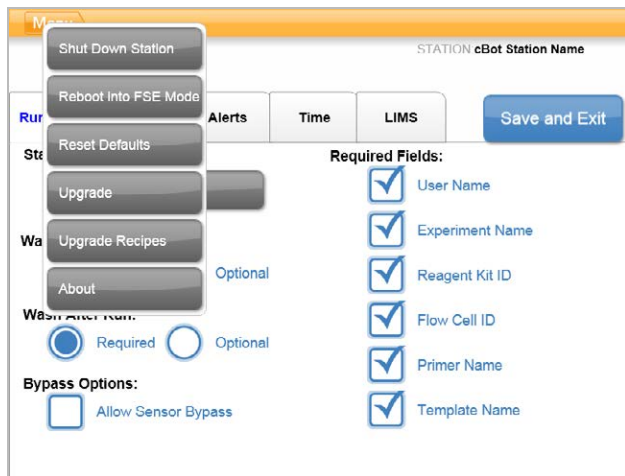

- After the software shuts down, switch the power switch to the OFF position.

## Reboot in FSE Mode

The option to reboot in FSE Mode is for use by a trained Illumina Field Application Scientist (FAS) or Field Service Engineer (FSE) to update software or service the instrument.



# Appendix A Troubleshooting

Pause or Abort a Run .....	41
Troubleshoot Flow Check Failure .....	41
Troubleshoot Run Problems .....	43
Reset the Barcode Scanner .....	44
Edit Protocols .....	45

## Pause or Abort a Run

Use commands on the Run Status screen to pause or abort a run.

- ▶ **Pause**—Completes the current command in the protocol, and then pauses the run. Allow a few minutes before the run pauses. When the run is paused, the sippers lift from the reagent tubes, the reagent stage returns the home position, and the Pause button changes to the Resume button.
  - ▶ When the run is active, select **Pause** to pause the run.
  - ▶ When the run is paused, select **Resume** to resume the run.
- ▶ **Abort Run**—Ends the run without the option of resuming. Select **Unload** to unload run components.

## Troubleshoot Flow Check Failure

Perform the following procedure to troubleshoot flow check failure. Do not select the option to bypass flow check until you have completed this procedure to determine the following conditions:

- ▶ The flow cell is properly positioned on the instrument.
- ▶ The manifold and hardware are working properly.



### CAUTION

Bypassing the flow check can result in unsuccessful clustering of some lanes.

Because different flow cell types use different flow checks, make sure that you use the correct recipe, manifold, and flow cell combination.

- 1 Make sure that you have enough HT1 in row 1 of the reagent plate, and replenish as needed.
- 2 Note which lanes failed the flow check. This information is provided on the top-left corner of the interface screen.
  - ▶ If all eight lanes failed, the flow cell is probably loaded improperly. Remove the manifold and confirm that the flow cell holes are facing upward, and the flow cell orientation is correct.
  - ▶ If only some lanes failed, the flow cell might not be seated. Remove the manifold, reseal the flow cell, and then reinstall the manifold.
- 3 Select **Rerun Check** to repeat the flow check a second time.
- 4 If the flow check fails a second time, note which lanes failed the flow check, and do one of the following:
  - ▶ If all 8 lanes failed, you probably have a faulty manifold. Replace it with a new manifold.
  - ▶ If different lanes failed, you probably do not have a faulty manifold. Inspect the volumes of HT1 in row 1 to make sure that the tubes contain equal volumes.
- 5 Select **Rerun Check** to repeat the flow check for a third time.
  - ▶ If this flow check fails after replacing the manifold, go to step 6.
  - ▶ If this check fails and you did not need to replace the manifold, go to step 7.
- 6 If the flow check fails a third time after replacing the manifold, you might have a clog in the hardware.

- a Inspect the volumes of HT1 in row 1 to make sure that the tubes contain equal volumes. Higher volumes in the tubes that correspond to lanes with repeated flow check failure indicate a hardware clog.
  - b Unload the run components and perform a maintenance wash.
  - c After the wash, turn off the instrument using the power switch. After a few seconds, turn on the power switch and then press the start button to restart the software. Power cycling the instrument resets the allowable number of pre-run check attempts.
  - d Follow the software prompts to reload run components and set up your run.
- 7 If the flow check fails a third time, you can safely bypass the flow check:
- a Select **Bypass Flow Check** to proceed with the run.
  - b After the run, check reagent delivery from all tubes.

## Troubleshooting Flowchart

The following flowchart illustrates the troubleshooting procedure. Steps to repeat the flow check include a number to indicate how many of the allowed flow checks have been performed at that point in the procedure.

Figure 26 Troubleshooting Flowchart

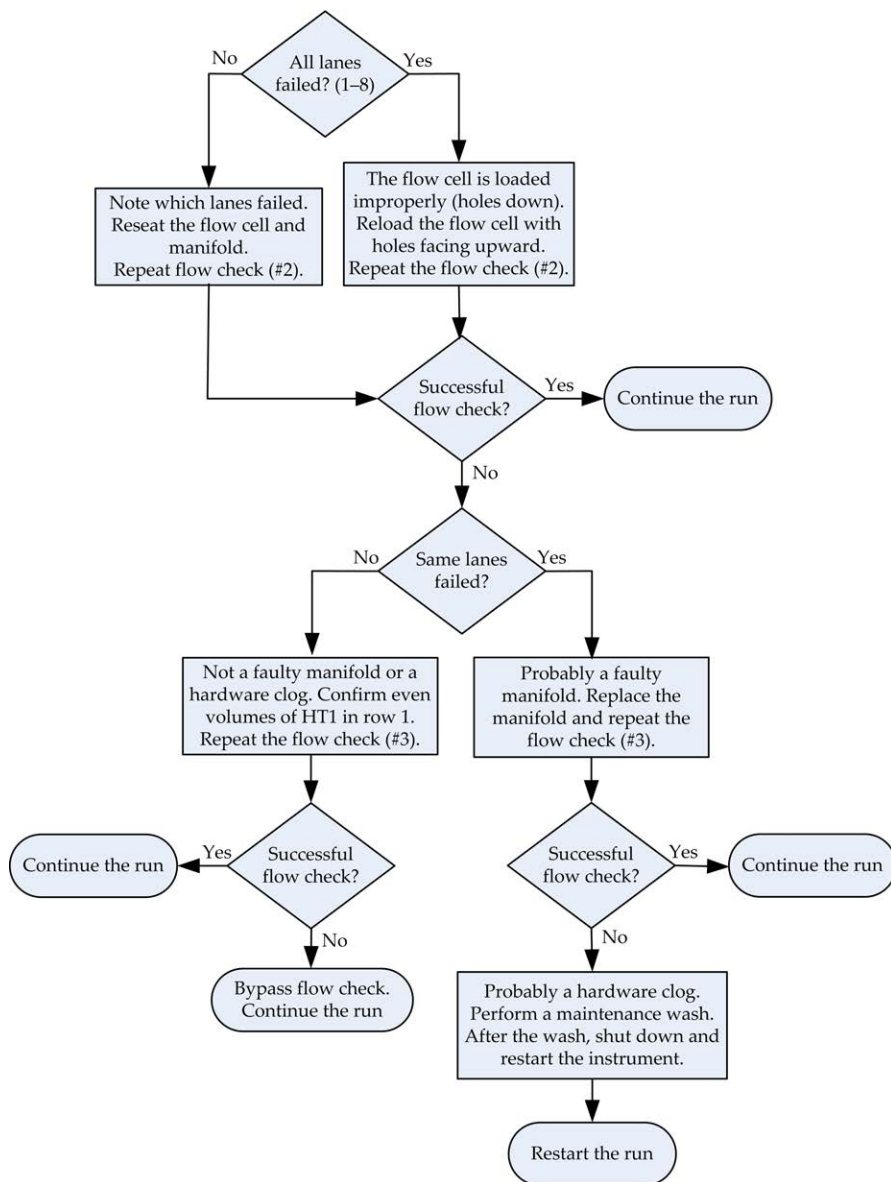

## Troubleshoot Run Problems

Use the following table to troubleshoot problems encountered during a cluster generation run.

Problem	Possible Cause	Action
Temperature out of range	Often indicates that the cBot did not reach the set temperature in the expected time. Can also indicate a potential control board failure.	Email Illumina Technical Support.
Coolant is flowing and coolant level is low	Coolant has slowly evaporated to a low level.	Add Illumina coolant (part # 1003709) to the coolant reservoir.
Coolant is not flowing and coolant level is low	Coolant level might be too low to generate flow.	Add Illumina coolant (part # 1003709) to the coolant reservoir.
Coolant is not flowing and coolant level is not low	Potential coolant pump failure.	Email Illumina Technical Support.
Instrument is in a locked state	Potential software error.	Email Illumina Technical Support.

## Reset the Barcode Scanner

The barcode scanner is ready for use when you receive your cBot. If the scanner is reset to an incorrect configuration, use the following instructions to restore it to the default configuration.

- 1 Print the barcode.

Figure 27 Restore Defaults Barcode



- 2 From the start screen, select **Menu** and then **Manual Commands**.
- 3 Select the **General** tab to access the barcode reader manual control inputs.

Figure 28 Manual Commands, General Tab

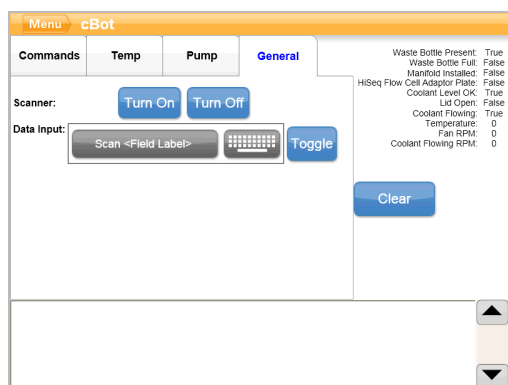

- 4 Select **Turn Off** and then select **Turn On** to activate the barcode scanner. The laser line is visible on the scanner plate under the LCD screen.
- 5 Place the barcode under the barcode scanner.
- 6 Select **Turn Off**, and then **Turn On** to scan the barcode. A beep indicates a successful scan.

## Edit Protocols

Use the Protocol Editor to edit protocols to fit your needs. You might want to repeat steps in a protocol, or change the number of amplification cycles in the chemistry section.

Each protocol consists of two main sections:

- ▶ **Chemistry section**—Contains instructions for pumping reagents, temperature changes, and wait durations. This section appears in the upper portion of the Protocol Editor screen.
- ▶ **Protocol section**—Contains a series of steps made up of chemistry definitions. This section appears in the lower portion of the Protocol Editor screen.

If you edit an existing protocol, make sure to rename your protocol.

## Protocol Editor



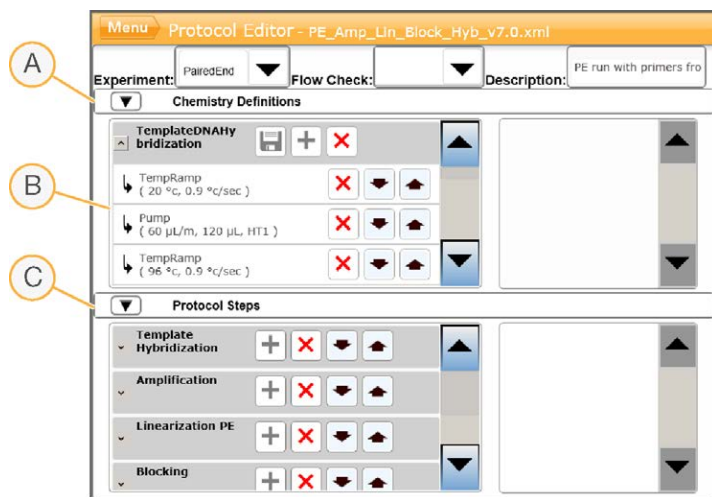

- 1 From the Start screen, select **Menu**, and then select **Protocol Editor**.
- 2 From the Protocol Editor, select **Menu**, and then select the appropriate command:
  - ▶ **Open**—Opens an existing protocol.
  - ▶ Select **Load from Library**—Loads an existing chemistry definition or protocol step stored in the cBot library.
  - ▶ Select **New Chemistry Definition** or **New Protocol Step**—Creates a definition or step and stores it in the cBot library.
- 3 Use the down arrow to the left of the step to expand the commands in the step. Use the up arrow to collapse the commands.
- 4 To edit a step in a chemistry definition, highlight the step. Selections to change the pump, temperature ramp, or wait commands appear in the right-hand panel.
- 5 To edit a step in the protocol, highlight the step. Selections to change to the number of cycles for the selected chemistry definition appear in the right-hand panel.
- 6 Use the Protocol Editor icons to the right of the step name to rearrange, delete, or copy steps and commands.

Figure 29 Protocol Editor, Expanded Steps



- A Chemistry section
- B Expanded chemistry section
- C Protocol section

## Protocol Editor Icons

Icon	Description
	Moves the highlighted step below the following step in the protocol.
	Moves the highlighted step above the preceding step in the protocol.
	Deletes the highlighted step.
	Repeats the highlighted step.
	Saves your changes to the protocol library.

# Index

## 5

5% DECON 36

## 8

8-tube strip removal 33

## A

adapter plates 36  
washing 28

## B

barcode scanner  
cleaning 35  
resetting 44  
best practices  
reagent preparation 16  
bypass flow check 41

## C

cBot reagent plates 12  
chemistry protocols 45  
clustering duration 31  
clustering reagents  
preparing 16  
clustering steps 31  
components 8  
configuration 10-11  
consumables  
unloading 32  
version compatibility 14  
consumables, user-supplied  
reagent preparation 15  
coolant  
level 35  
coolant part number 43  
coolant problems 43  
customer support 50

## D

DECON 36  
DECON substitute 35  
delivered volumes 33

denaturing 25  
denaturing libraries 18, 22  
diluting 25  
documentation 7, 50

## E

ending a run 41  
error messages 43  
ExAmp master mix 23  
ExAmp reaction  
preparing, 1 flow cell 19  
preparing, 4 flow cells 20  
ExAmp reagents  
about 16, 20  
preparing 23  
preparing, 1 flow cell 19  
preparing, 4 flow cells 20  
thawing 18, 22

## F

flow cell  
cleaning 16, 20  
compatible recipes 14  
packaging 16, 20  
preparation 16, 20  
storage 31  
flow cell storage 28, 32  
flow cells  
adapter plates 36  
positioning 28  
preparing for loading 28  
flow check 30  
troubleshooting failure 41  
flow check failure  
troubleshooting 42  
flow check failures 43  
foil not pierced 33  
FSE mode 40

## H

help  
documentation 7  
help, technical 50  
HP10, preparing 24

**I**

icons  
 sensor status 10  
 idle state 39

**K**

kit documentation 11

**L**

libraries  
 denaturing 18, 22  
 diluting 18, 22  
 loading 29  
 loading concentration 18, 22

**M**

maintenance 33, 35  
 periodic care 35  
 maintenance wash duration 35  
 maintenance, preventive 35  
 manifold  
 outlet clamp 29  
 sipper comb 8, 29  
 manifold problems 43  
 manifolds 28  
 Manual Commands 36

**N**

NaOH 36

**P**

part numbers  
 coolant 43  
 PhiX  
 adding 18, 22  
 spike-in % 18, 22  
 positioning flow cells 28  
 post-run procedures 32  
 post-run wash 35  
 pre-run check  
 errors 30  
 performing 30  
 pre-run wash 35

preventive maintenance 35  
 primers  
 custom 30  
 loading 30  
 name, entering 30  
 tube strip orientation 30  
 protocol  
 selecting 27  
 Protocol Editor 45  
 icons 46  
 protocols, editing 45

**R**

reagent delivery, unsuccessful 33  
 reagent plate 9  
 configurations 12  
 preparing 19, 23  
 thawing 18, 22-24  
 reagent plate, high output  
 preparing 24  
 reagent plate, rapid  
 preparing 24  
 reagent plates  
 positioning 27  
 reagent preparation  
 best practices 16  
 reagent stage 9  
 reagents, preparing  
 high output 23  
 HiSeq 3000/4000 20  
 HiSeq X flow cell 16  
 rapid 24  
 recipes  
 list of 14  
 upgrading 38  
 removing 8-tube strips 33  
 resuming a run 41  
 run  
 starting 30  
 run component errors 30  
 run data report 31  
 run progress 31  
 run requirements  
 configuring 11  
 Run Status screen 31  
 run summary 31

**S**

salts, removing 33



- seal, white foil 27
- seals not pierced 33
- sensor status icons 10
- sensors 8
- servicing 40
- shutting down 39
- software
  - upgrading 37
  - version compatibility 14
- software errors 43
- stopping a run 41
- storing flow cells 31-32
- system status 10

## T

- technical assistance 50
- temperature out of range 43
- temperature range 43
- templates
  - loading 29
- thawing reagent plate 18, 22
- thermal stage 8
  - washing 33
- troubleshooting
  - flow check failure 41
- turning off 39

## U

- user-supplied consumables
  - reagent preparation 15

## V

- version compatibility
  - consumables 14
  - software 14

## W

- wash reservoir 26
- washes 26
  - frequency 35
- washing
  - adapter plates 28
- washing the instrument 33
- waste bottle 35
- white foil seal 27

# Technical Assistance

For technical assistance, contact Illumina Technical Support.

Website: [www.illumina.com](http://www.illumina.com)  
Email: [techsupport@illumina.com](mailto:techsupport@illumina.com)

## Illumina Customer Support Telephone Numbers

Region	Toll Free	Regional
North America	+1.800.809.4566	
Australia	+1.800.775.688	
Austria	+43 800006249	+43 19286540
Belgium	+32 80077160	+32 34002973
China	400.066.5835	
Denmark	+45 80820183	+45 89871156
Finland	+358 800918363	+358 974790110
France	+33 805102193	+33 170770446
Germany	+49 8001014940	+49 8938035677
Hong Kong, China	800960230	
Ireland	+353 1800936608	+353 016950506
Italy	+39 800985513	+39 236003759
Japan	0800.111.5011	
Netherlands	+31 8000222493	+31 207132960
New Zealand	0800.451.650	
Norway	+47 800 16836	+47 21939693
Singapore	+1.800.579.2745	
South Korea	+82 80 234 5300	
Spain	+34 911899417	+34 800300143
Sweden	+46 850619671	+46 200883979
Switzerland	+41 565800000	+41 800200442
Taiwan, China	00806651752	
United Kingdom	+44 8000126019	+44 2073057197
Other countries	+44.1799.534000	

Safety data sheets (SDSs)—Available on the Illumina website at [support.illumina.com/sds.html](http://support.illumina.com/sds.html).

Product documentation—Available for download from [support.illumina.com](http://support.illumina.com).



Illumina  
5200 Illumina Way  
San Diego, California 92122 U.S.A.  
+1.800.809.ILMN (4566)  
+1.858.202.4566 (outside North America)  
techsupport@illumina.com  
www.illumina.com

**For Research Use Only. Not for use in diagnostic procedures.**

© 2020 Illumina, Inc. All rights reserved.

**illumina**<sup>®</sup>