

Infinium LCG Assay

Reference Guide

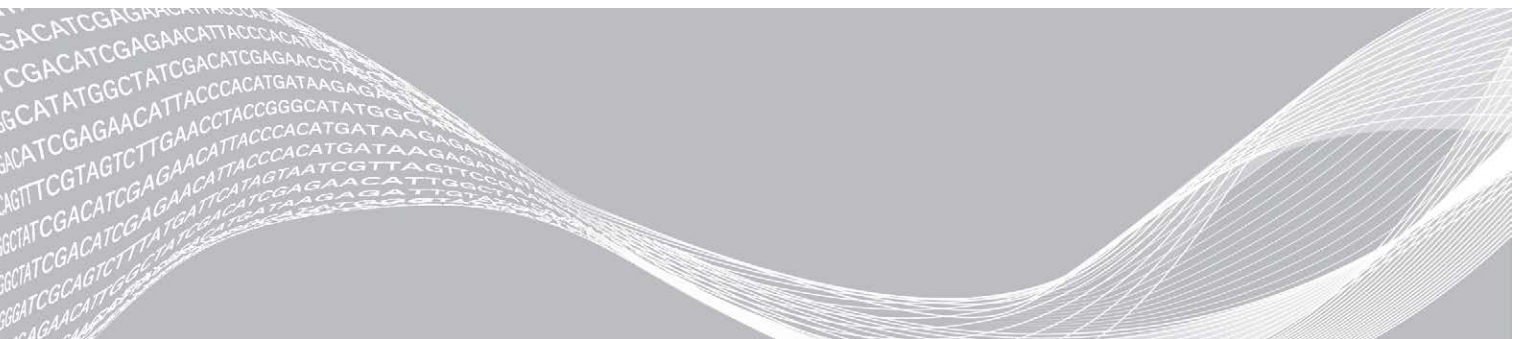

This document and its contents are proprietary to Illumina, Inc. and its affiliates ("Illumina"), and are intended solely for the contractual use of its customer in connection with the use of the product(s) described herein and for no other purpose. This document and its contents shall not be used or distributed for any other purpose and/or otherwise communicated, disclosed, or reproduced in any way whatsoever without the prior written consent of Illumina. Illumina does not convey any license under its patent, trademark, copyright, or common-law rights nor similar rights of any third parties by this document.

The instructions in this document must be strictly and explicitly followed by qualified and properly trained personnel in order to ensure the proper and safe use of the product(s) described herein. All of the contents of this document must be fully read and understood prior to using such product(s).

FAILURE TO COMPLETELY READ AND EXPLICITLY FOLLOW ALL OF THE INSTRUCTIONS CONTAINED HEREIN MAY RESULT IN DAMAGE TO THE PRODUCT(S), INJURY TO PERSONS, INCLUDING TO USERS OR OTHERS, AND DAMAGE TO OTHER PROPERTY, AND WILL VOID ANY WARRANTY APPLICABLE TO THE PRODUCT(S).

ILLUMINA DOES NOT ASSUME ANY LIABILITY ARISING OUT OF THE IMPROPER USE OF THE PRODUCT(S) DESCRIBED HEREIN (INCLUDING PARTS THEREOF OR SOFTWARE).

© 2019 Illumina, Inc. All rights reserved.

All trademarks are the property of Illumina, Inc. or their respective owners. For specific trademark information, see www.illumina.com/company/legal.html.

Revision History

Document	Date	Description of Change
Document # 15023139 v04	August 2019	Removed all references to WG# in barcode information in regards to DNA plates and MSA plates. Added Barcode Numbers section to Tips and Techniques to explain the new barcode numbering scheme.
Document # 15023139 v03	June 2019	Corrected Reagent Reuse in Tips and Techniques. XC4 is reusable not LX2. Corrected storage temperatures of MA1, PB1, PM1, XC3, and XC4. Corrected reagents listed in first and last bullets of About Reagents section in the Extend and Stain introduction.
Document # 15023139 v02	May 2019	Changed document name to <i>Infinium LCG Assay Reference Guide</i> . Document updated to reflect latest style and formatting standards. Added Preparation and Storage of User-Supplied Reagent section to consolidate reagent preparation and use instructions. Reference to Experienced User Cards replaced with <i>Infinium LCG Assay Checklist Manual Protocol (document # 1000000074606)</i> and <i>Infinium LCG Assay Checklist Automated Protocol (document # 1000000074607)</i> which provide current format of experienced user instructions. Added list of acronyms. Consumables and equipment information moved to <i>Infinium Assay Lab Setup and Procedures Guide (document # 11322460)</i> . Added Tip and Techniques section, includes: <ul style="list-style-type: none"> • Tips, techniques, and general reagent storage and preparation information previously documented in protocol sections. • Directions to seal plates before vortex and centrifuge steps. • BeadChip handling. • Hybridization Chamber handling. Added Illumina LIMS and No Illumina LIMS sections to consolidate repeated LIMS/no LIMS steps.
Document # 15023139 v01	October 2015	Updated the total volume of PB1 required depending on the number of alignment fixtures being used.

Document	Date	Description of Change
Document # 15023139 rev. D	June 2015	Corrected the Amplification temperature to 37°C.
Document # 15023139 rev. C	May 2012	Indicated that up to 24 BeadChips can be washed with 550 ml of PB1.
Document # 15023139 rev. B	September 2011	Reagents Supplied table amended to delete part numbers and move descriptions to second column.
Document # 15023139 rev. A	April 2011	Initial release.

Table of Contents

Chapter 1 Overview	1
Introduction to Infinium LCG Assay	1
Important Note	1
Additional Resources	2
DMAP Files	2
Preparation and Storage of User-Supplied Reagents	2
Tips and Techniques	3
Acronyms	5
Illumina LIMS	5
No Illumina LIMS	6
Chapter 2 Manual Protocol	7
Introduction	7
Infinium LCG Manual Workflow	7
Quantify DNA (Optional)	9
Amplify DNA	13
Incubate DNA	14
Fragment DNA	14
Precipitate DNA	15
Resuspend DNA	17
Hybridize DNA to the BeadChip	18
Wash BeadChips	24
Extend and Stain BeadChips	29
Image BeadChip	38
Illumina GenomeStudio	39
Chapter 3 Automated Protocol	40
Introduction	40
Infinium LCG Automated Workflow	40
Quantify DNA (Optional)	42
Amplify DNA	46
Incubate DNA	48
Fragment DNA	48
Precipitate DNA	49
Resuspend DNA	52
Hybridize DNA to the BeadChip	53
Wash BeadChips	59
Extend and Stain BeadChips	64
Image BeadChip	73
Illumina GenomeStudio	74
Technical Assistance	75

Chapter 1 Overview

Introduction to Infinium LCG Assay	1
Important Note	1
Additional Resources	2
DMAP Files	2
Preparation and Storage of User-Supplied Reagents	2
Tips and Techniques	3
Acronyms	5
Illumina LIMS	5
No Illumina LIMS	6

Introduction to Infinium LCG Assay

The Illumina Infinium LCG Assay transforms DNA analysis by streamlining sample preparation and enabling high multiplexing. Using Infinium I and Infinium II probe designs and a dual-color channel approach, the Infinium LCG Assay enables the DNA analysis of up to several million SNPs and CNV markers per sample.

The Infinium LCG Assay accomplishes this unlimited multiplexing by combining whole-genome amplification (WGA) sample preparation with direct, array-based capture, and enzymatic scoring of the SNP loci. Locus discrimination or copy number variation (CNV) determination comes from a combination of high bead type representation per feature, sequence-specific hybridization capture, and array-based, single-base primer extension. With the Infinium I probe design, the 3' end of the primer overlaps with the SNP site. If there is a perfect match, extension occurs and signal is generated. If there is a mismatch, extension does not occur and no signal is generated. In the case of the Infinium II probe design, the 3' end of the primer is positioned directly adjacent to the SNP site, or if a nonpolymorphic probe, directly adjacent to the nonpolymorphic site.

Allele-specific, single-base extension of the primer incorporates a biotin nucleotide or a dinitrophenyl labeled nucleotide. C and G nucleotides are biotin labeled. A and T nucleotides are dinitrophenyl labeled. Signal amplification of the incorporated label further improves the overall signal-to-noise ratio of the assay.

The Infinium LCG Assay offers:

- ▶ High multiplexing
- ▶ High call rate and accuracy
- ▶ Unlimited genomewide marker selection
- ▶ Single tube amplification, single chip, no PCR
- ▶ Minimal risk of carryover contamination
- ▶ Low DNA input—200 ng per sample
- ▶ Walk-away automation using Tecan Genesis or Freedom Evo Robots and Tecan GenePaint system
- ▶ Compatibility with both Illumina iScan and HiScan Systems
- ▶ Multiplesample BeadChip format

Important Note

Before using the procedures in this guide, read the *Infinium Assay Lab Setup and Procedures Guide* (document # 11322460). The *Setup and Procedures* guide explains how to equip and run an Infinium LCG Assay laboratory, including information on the following topics:

- ▶ Prevention of amplification product contamination
- ▶ Safety precautions

- ▶ Consumables and equipment to purchase in advance
- ▶ Standard lab procedures
- ▶ Robot use for automation
- ▶ Preparation for BeadChip imaging
- ▶ System Controls
- ▶ System maintenance
- ▶ Troubleshooting

The instructions apply equally to all Infinium BeadChips provided by Illumina™. All Infinium LCG documentation assumes that you have already set up the laboratory space and that you are familiar with the standard procedures and safety precautions.

Additional Resources

The Infinium LCG Assay support pages on the Illumina website provide additional kit resources. These resources include software downloads, training, product compatibility, and the following documentation. Always check support pages for the latest versions.

Resource	Description
<i>Infinium LCG Assay Checklist Manual Protocol (document # 1000000074606)</i>	Provides a checklist of steps for experienced users of the Infinium LCG Assay when performing the manual protocol.
<i>Infinium LCG Assay Checklist Automated Protocol (document # 1000000074607)</i>	Provides a checklist of steps for experienced users of the Infinium LCG Assay when performing the automated protocol.
<i>Infinium LCG Assay Lab Tracking Form (document # 15023142)</i>	Used to map DNA samples to BeadChips and record the barcode of each reagent and plate used in the protocol.
<i>Sample Sheets</i>	Sample sheets for your product to record information about your samples for later use in data analysis.
<i>Infinium Assay Lab Setup and Procedures Guide (document # 11322460)</i>	Describes how to set up an Workflow lab including reagents, consumables, and equipment to purchase in advance, and best practices for lab operation.
<i>Infinium Consumables and Equipment List (document # 1000000084294)</i>	Provides an interactive checklist of Illumina-provided and user-provided consumables and equipment.

DMAP Files

Before run setup, download the DMAP files for the arrays, and prepare a sample sheet. Use the Decode File Client to download the DMAP files.

Preparation and Storage of User-Supplied Reagents

- ▶ Maintain a first in, first out (FIFO) system for reagents. Rotate the stock of the remaining reagents to avoid using expired reagents.
- ▶ Infinium LCG kits contain reagents in exact quantities needed for the assay. Measure reagents carefully to avoid shortages.
- ▶ Use fresh reagents for each batch of plates, and empty reservoirs between batches.

- ▶ To minimize errors when preparing user-supplied reagents, prepare large batches of 0.1 N NaOH and 95% Formamide/1 mM EDTA using the following guidance.

Preparing Batches of 0.1 N NaOH

Prepare fresh 0.1 N NaOH in large batches. Divide batches into 15 ml or 50 ml sealed tubes.

Store the sealed tubes for 6 months at 2°C to 8°C and use the stored 0.1 N NaOH as needed. Use the 0.1 N NaOH the same day you open the tube, and discard any unused amounts.

Preparing Batches of 95% Formamide/1 mM EDTA

Prepare the 95% formamide/1 mM EDTA mixture in large batches. Divide batches into 15 ml or 50 ml sealed tubes.

Store the sealed tubes for up to 6 months at -25°C to -15°C and use the stored mixture as needed. Use the mixture the same day you open the tube, and discard any unused amounts.

Use Fresh RA1 Reagent for Each Step

Use fresh RA1 for each step in the assay where it is required. RA1 that has been stored properly and has not been dispensed for use in either the XStain or Resuspension step is considered fresh RA1. After RA1 has been exposed to room temperature air for extended periods of time, it is no longer fresh.

To make best use of RA1, only pour the amount needed for the current step. If you plan to perform additional assay steps requiring RA1 the same day, leave the remaining thawed reagent in the original, closed bottle at room temperature until it is needed. Follow the standard RA1 storage procedures described in this guide for next-day processing and prolonged storage conditions.

Tips and Techniques

Unless a safe stopping point is specified, proceed immediately to the next step.

Avoiding Cross-Contamination

- ▶ When adding or transferring samples, change tips between *each sample*.

Reagent Reuse

- ▶ After each protocol step, discard unused reagents per facility standards.
- ▶ The volume of each wash buffer (PB1 and LX2) is sufficient for one use.
- ▶ XC4 is reusable up to six times during a two-week period (maximum 24 BeadChips).

Barcode Numbers

- ▶ Barcode serial numbers used for workflow enforcement and positive sample tracking on MSA plates, DNA plates, and reagents use a numbering pattern of two alphanumeric characters followed by seven random numbers.

Sealing the Plate

- ▶ Always seal plates before vortex and centrifuge steps in the protocol.
- ▶ Orient sealing mats so that the A1 on a cap matches the A1 on the plate.

- ▶ Make sure that all 96 caps are securely seated in the wells to prevent evaporation and spills, which introduce variability and cross-contamination.
- ▶ Remove sealing mats slowly and carefully to prevent splashing, and then set aside upside-down in a safe location.
- ▶ When returning a sealing mat to a plate, make sure that the orientation is correct.

Heat Sealer

- ▶ If you are using the ALPS 50 V model heat sealer, set it to 165°C and 2.5 seconds.

Pipetting

- ▶ Make sure that pipettes are properly calibrated, clean, and decontaminated.
- ▶ Dispense slowly and carefully to prevent turbulence in the plate wells and flow-through chambers.
- ▶ Use a multichannel pipette whenever possible.

Centrifugation

- ▶ When centrifuging plates or BeadChips, place a balance plate or rack with BeadChips opposite each plate or rack being centrifuged. Make sure that the weights are as similar as possible.

Handling BeadChips

- ▶ Touch the BeadChip at the barcode or along the edges only. Avoid the beadstripe area and sample inlets.
- ▶ BeadChips are glass. Inspect them for broken edges before use and handle with care.

Washing and Coating BeadChips

Do the following before starting the wash and coat process:

- ▶ Place wash dish covers on wash dishes when not in use.
- ▶ Clean wash dishes with low-pressure air to remove particulates before use.
- ▶ Wash tube racks and dishes thoroughly before and after use. Rinse with DI H₂O. Place them upside down on wash rack to dry.
- ▶ Prepare an additional clean tube rack that fits the internal dimensions of the vacuum desiccator. Allow one rack per eight BeadChips.

Handling Hybridization Chambers

- ▶ Keep the chamber lids and bases together. Adopt a labeling convention that pairs each chamber base with the original lid.
- ▶ Regularly check lid-base pairs to make sure that they fit securely. Also check hinges for signs of abnormal wear or loose fittings. An airtight seal requires that the hinges have adequate clamping strength.
- ▶ Record which hybridization chamber was used for each BeadChip. If sample evaporation or other processing anomalies occur, the appropriate hybridization chambers can be investigated.
- ▶ When the hybridization chamber inserts contain BeadChips, keep them steady and level when lifting or moving.
 - ▶ Avoid shaking, and always keep parallel to the lab bench.
 - ▶ Do not hold by the sides near the sample inlets.

Acronyms

Acronym	Definition
ATM	Anti-Stain Two-Color Master Mix
DI H ₂ O	Deionized water
EDTA	Ethylenediaminetetraacetic acid
EtOH	Ethanol
EML	Extension mix long
FMS	Fragmentation solution
LX1	Long XStain solution 1
LX2	Long XStain solution 2
MA1	Multi-Sample Amplification Mix 1
RPM	Random Primer Mix
MSM	Multi-Sample Amplification Master Mix
Midi plate	Acceptable 96-well plate for MSA6 plate
MSA6 plate	Midi plate used in the amplification through hybridization steps
NaOH	Sodium hydroxide
PB1	Wash buffer
PB2	Humidifying buffer used during hybridization
PM1	Precipitation solution
RA1	Resuspension, hybridization, and wash solution
SML	Superior Two-Color Master Mix
XC3	XStain BeadChip solution 3
XC4	XStain BeadChip solution 4

Illumina LIMS

If you are using the automated protocol with Illumina LIMS, follow these guidelines:

- ▶ At each step in the protocol, make sure that the **Use Barcodes** checkbox is selected.
- ▶ The barcode must be on the right side of the plate. Make sure the barcode label fits between the notches and does not cover the holes on the top of the plate.

Figure 1 Correctly Placed Barcodes

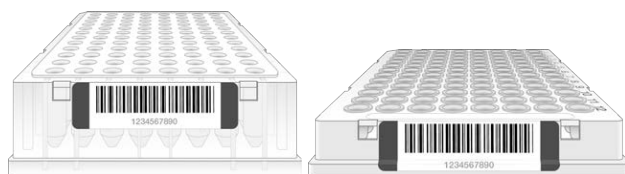

- ▶ When prompted, enter the number of samples, plates, or BeadChips, and then select **OK**.
- ▶ Each time you select **Run** to start a new process, you are prompted to log in to LIMS.
- ▶ If prompted to select the project and the batch ID or DNA plate, do one of the following:
 - ▶ Select your current project. The available batches appear in the Sample Batch ID pane. Select a batch to see the associated DNA plate appear in the DNA Plates pane.

- ▶ Use **Search** to search for a specific Batch ID or DNA plate.
- ▶ Some steps require verification in LIMS before you can start.
 - ▶ If verification is successful, a blue confirmation message appears at the top of the window.
 - ▶ If the verification fails, a red error message appears at the top of the window. Do **not** proceed. Instead, follow these steps to troubleshoot the problem:
 - a Select the Reports tab in the upper-right corner.
 - b In the left pane, select **Tracking Reports | Get Queue Status**.
 - c Scan the plate barcode, and select **Go**.
 - d Note which step the plate is queued to run, and proceed with that step.

No Illumina LIMS

If you are using the automated protocol without Illumina LIMS do the following:

- ▶ At each step in the protocol, make sure that the **Use Barcodes** checkbox is cleared.
- ▶ At each step in the protocol, you are prompted to enter the number of samples, plates, or BeadChips. Enter the requested information, and then select **OK**.

Chapter 2 Manual Protocol

Introduction	7
Infinium LCG Manual Workflow	7
Quantify DNA (Optional)	9
Amplify DNA	13
Incubate DNA	14
Fragment DNA	14
Precipitate DNA	15
Resuspend DNA	17
Hybridize DNA to the BeadChip	18
Wash BeadChips	24
Extend and Stain BeadChips	29
Image BeadChip	38
Illumina GenomeStudio	39

Introduction

This section describes pre- and post-amplification manual laboratory protocols for the Infinium LCG Assay. Follow the protocols in the order shown.

Infinium LCG Manual Workflow

The following diagram illustrates the Infinium LCG Assay manual workflow for the Infinium LCG Assay BeadChips. These protocols describe the procedure for preparing 96 DNA samples.

Figure 2 Illumina Infinium LCG Assay Manual Workflow

Day 1

1 Quantify DNA (Optional)
 Hands-on: 30 minutes/plate
 Fluorometer: 5 minutes/plate
 Reagents: PicoGreen dsDNA quantification
 Output: Sample DNA plate with quantitated DNA

Safe Stopping Point

2 Amplify DNA
 Hands-on: ~1 hour
 Reagents: 0.1 N NaOH, MA1, RPM, MSM
 Output: MSA6 plate

3 Incubate DNA
 Incubation: 20–24 hours
 Output: MSA6 plate with amplified DNA

Overnight Incubation

Day 2

4 Fragment DNA
 Hands-on: ~30 minutes
 Incubation: 1 hour
 Reagents: FMS
 Output: MSA6 plate

Safe Stopping Point

5 Precipitate DNA
 Hands-on: 30 minutes
 Incubation/dry time: ~2 hours
 Reagents: 2-propanol, PM1
 Output: MSA6 plate

Safe Stopping Point

6 Resuspend DNA
 Hands-on: ~30 minutes
 Incubation: 1 hour
 Reagents: RA1
 Output: MSA6 plate

Safe Stopping Point

7 Hybridize DNA to BeadChip
 Hands-on: ~30 minutes
 Incubation: 20 minutes
 Cool down: 30 minutes
 Incubation: 16–24 hours
 Reagents: 100% EtOH, PB2, XC4

Overnight Incubation

Day 3

8 Wash BeadChip
 Hands-on: ~20 minutes/4 BeadChips
 Cool down: 25 minutes
 Reagents: PB1
 Output: BeadChip

9 Extend and Stain BeadChip
 Hands-on: ~2.5 hours
 Cool down: 25 minutes
 Reagents: 75% EtOH, 95% form/EDTA, ATM, EML, LX1, LX2, PB1, RA1, SML, XC3, XC4
 Output: BeadChip

10 Image BeadChip
 Scanning: 52 minutes/BeadChip
 Output: Image and data files

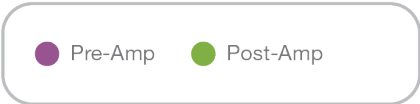

Quantify DNA (Optional)

This step uses the PicoGreen dsDNA quantification reagent to quantify double-stranded DNA samples. Quantify up to 6 plates, each containing up to 96 samples.

Consumables

- ▶ PicoGreen dsDNA quantification reagent
- ▶ 1X TE
- ▶ Lambda DNA
- ▶ 96-well 0.65 ml microplates
- ▶ FLUOTRAC 200 96-well flat-bottom plate (1 per standard DNA plate/1 per sample DNA plate)

About Reagent

- ▶ Do not use glass containers with PicoGreen. It degrades quickly in the presence of light and can adhere to glass, which lowers its effective concentration in solution and affects the upper response range accuracy.

Preparation

- 1 Prepare the following consumable:

Item	Storage	Instructions
PicoGreen dsDNA quantification reagent	2° to 8°C	Thaw at room temperature for 60 minutes in a light-impermeable container.

- 2 Label the 96-well microplate **Standard DNA**.
- 3 Label the FLUOTRAC plates **Standard QDNA** and **Sample QDNA**.
The Sample QDNA plate is for the quantified DNA.

Procedure

Make a Standard DNA Plate

This step creates a Standard DNA plate with serial dilutions of stock Lambda DNA in the wells of column 1.

- 1 Add stock Lambda DNA to well A1 in the Standard DNA plate and dilute to 75 ng/μl in a final volume of 233.3 μl. Pipette up and down several times to mix.
 - ▶ Use the following formula to calculate the amount of stock Lambda DNA:

$$\frac{(233.3 \mu\text{l}) \times (75 \text{ ng} / \mu\text{l})}{(\text{stock Lambda DNA concentration})} = \mu\text{l stock Lambda DNA to add to A1}$$
 - ▶ Dilute the stock DNA in well A1 using the following formula:

$$\mu\text{l 1X TE to add to A1} = 233.3 \mu\text{l} - \mu\text{l stock Lambda DNA in well A1}$$
- 2 Add 66.7 μl 1X TE to well B1.
- 3 Add 100 μl 1X TE to the remaining wells of column 1.

Figure 3 Dilution of Stock Lambda DNA Standard

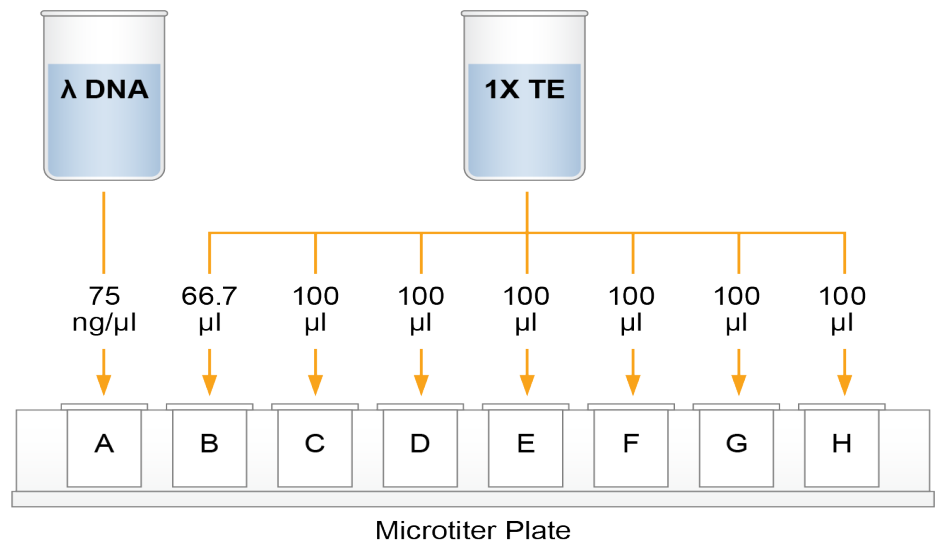

- 4 Transfer 133.3 μ l Lambda DNA from well A1 to well B1. Pipette up and down several times to mix.
- 5 Transfer 100 μ l from well B1 to well C1. Pipette up and down several times to mix.
- 6 Repeat the sequential transfer of 100 μ l for wells D1, E1, F1, and G1. *Do not transfer from well G1 to H1.* Well H1 serves as the blank 0 ng/ μ l Lambda DNA.

Table 1 Concentrations of Lambda DNA

Row-Column	Concentration (ng/ μ l)	Final Volume in Well (μ l)
A1	75	100
B1	50	100
C1	25	100
D1	12.5	100
E1	6.25	100
F1	3.125	100
G1	1.5262	200
H1	0	100

Figure 4 Serial Dilutions of Lambda DNA
Standard DNA Plate with Serial Dilutions of Stock Lambda DNA

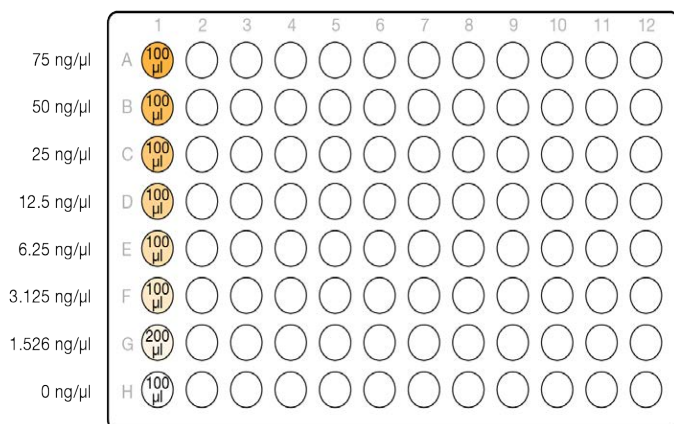

7 Cover the Standard DNA plate with a cap mat.

Dilute PicoGreen

In this step, PicoGreen is diluted for use in the subsequent *Create Standard QDNA Plate* and *Create Sample QDNA Plate* procedures.

1 Prepare a 1:200 dilution of PicoGreen to 1X TE using a sealable 100 ml or 250 ml Nalgene bottle wrapped in aluminum foil.

Use the following table to determine the volumes needed for 96-well QDNA plates.

Number of QDNA Plates	PicoGreen (µl)	1X TE (ml)
1	115	23
2	215	43
3	315	63

2 Cap the foil-wrapped bottle and vortex to mix.

Create Standard QDNA Plate

- 1 Transfer the PicoGreen/1X TE dilution into a clean reagent reservoir.
- 2 Transfer 195 µl PicoGreen/1X TE dilution from the Standard DNA plate to columns 1 and 2 of the Standard QDNA plate.
- 3 Transfer 2 µl stock Lambda DNA dilution from the Standard DNA plate to columns 1 and 2 of the Standard QDNA plate.

Figure 5 Standard QDNA Plate with PicoGreen/ 1xTE Dilution
Standard QDNA Plate with PicoGreen

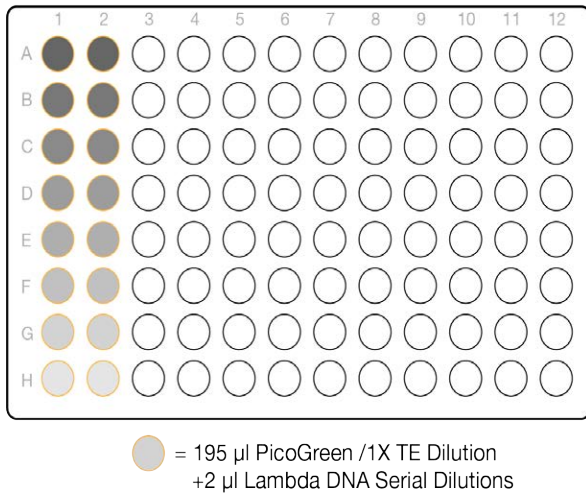

4 Immediately cover the plate with an adhesive aluminum seal.

Create Sample QDNA Plate

- 1 Transfer 195 µl PicoGreen/1xTE dilution to each sample well of the Sample QDNA plate.
- 2 Add 2 µl DNA sample to each well containing PicoGreen/1xTE.

Figure 6 Sample QDNA Plate with PicoGreen/ 1xTE Dilution
Sample QDNA Plate with PicoGreen

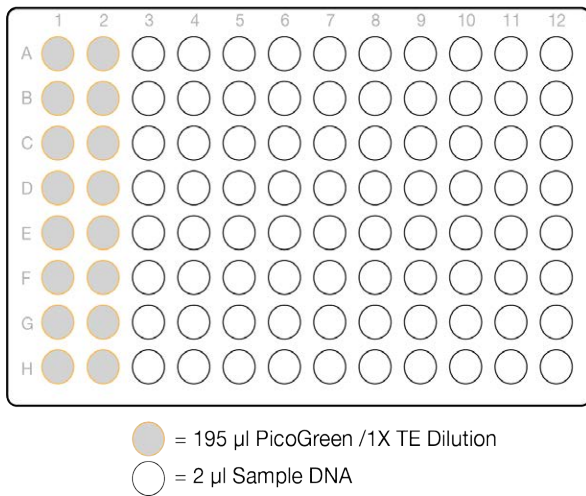

3 Immediately cover the plate with an adhesive aluminum seal.

Read QDNA Plate

This step compares the Sample QDNA plate data to the standard curve generated by the Standard QDNA plate to obtain the concentration of sample DNA. For best performance, use a minimum concentration of 50 ng/µl.

- 1 Turn on the spectrofluorometer.
- 2 Start the SoftMax Pro application.



NOTE

SoftMax Pro screens and menu options can vary based on the software version.

- 3 Load the Illumina QDNA.ppr file from the installation CD.
- 4 Select **Protocols | GTS_QDNA**.
- 5 Load the Standard QDNA plate into the spectrofluorometer tray with well A1 in the upper left corner.
- 6 Select **Illumina QDNA | SQDNA_STD**.
- 7 Select **Read**.
- 8 When the spectrofluorometer is finished reading the data, remove the plate from the tray.
- 9 Select **Standard Curve** to view the standard curve graph.
- 10 Review generated data and do one of the following:
 - ▶ Accept it and continue to the next step.
 - ▶ Repeat the *Make a Standard DNA Plate* process and regenerate the **Standard Curve**.
- 11 Load the first Sample QDNA plate in the spectrofluorometer tray with well A1 in the upper left corner.
- 12 Select **SQDNA** and then select **Read**.
- 13 When the spectrofluorometer is finished reading the data, remove the plate from the tray.
- 14 Repeat steps 11 through 13 to quantify all Sample QDNA plates.
- 15 When all plates have been read, select **File | Save** to save the output data file (*.pda).
- 16 Select **File | Import/Export | Export** and export the file as a *.txt file.
The *.txt file can be viewed in Microsoft Excel for data analysis.

SAFE STOPPING POINT

If you are stopping, store the plate(s) at 2°C to 8°C for up to 30 days.

Amplify DNA

This step adds the DNA samples to the plates. The samples are denatured and neutralized to prepare them for amplification.

Consumables

- ▶ MA1
- ▶ RPM
- ▶ MSM
- ▶ 0.1 N NaOH
- ▶ 96-well 0.8 ml microplates (midi)
- ▶ DNA plates with 96 DNA samples (50 ng/μl) (midi or TCY)
- ▶ Cap mats

Preparation

- 1 Preheat the Illumina Hybridization Oven in the post-amp area to 37°C and allow the temperature to equilibrate.
- 2 Prepare the following consumables:

Item	Storage	Instructions
DNA	-25°C to -15°C	Thaw at room temperature.
MA1	Room temperature	Thaw at room temperature. Invert 10 times to mix, and then pulse centrifuge to eliminate bubbles and collect reagent at the bottom of the tube.
RPM	-25°C to -15°C	Thaw at room temperature. Invert 10 times to mix, and then pulse centrifuge to eliminate bubbles and collect reagent at the bottom of the tube.
MSM	-25°C to -15°C	Thaw at room temperature. Invert 10 times to mix, and then pulse centrifuge to eliminate bubbles and collect reagent at the bottom of the tube.

- 3 Apply an MSA6 barcode label to a new midi plate.

Procedure

- 1 Add 20 µl MA1 to each well of the MSA6 plate.
- 2 Transfer 4 µl DNA sample from the DNA plate to the corresponding wells of the MSA6 plate.
- 3 Add 4 µl 0.1N NaOH in to each sample well of the MSA6 plate.
- 4 Seal the MSA6 plate with the 96-well cap mat.
 - ▶ Orient the mat so that A1 on the cap matches A1 on the plate.
 - ▶ Make sure that all 96 caps are securely seated in the wells.
- 5 Vortex at 1600 rpm for 1 minute, and then pulse centrifuge at 280 × g.
- 6 Incubate at room temperature for 10 minutes.
- 7 Remove the cap mat and set aside upside down in a safe location.
- 8 Add 68 µl RPM in to each sample well of the MSA6 plate.
- 9 Add 75 µl MSM in to each sample well of the MSA6 plate.
- 10 Reseal with the cap mat using the original orientation.
- 11 Vortex at 1600 rpm for 1 minute, and then pulse centrifuge at 280 × g.



NOTE

Perform the remaining protocol steps in the post-amplification area.

Incubate DNA

This step uniformly amplifies the genomic DNA, generating a sufficient quantity of each individual DNA sample to be used in the Infinium LCG Assay.

- 1 Incubate the MSA6 plate in the Illumina Hybridization Oven for 20–24 hours at 37°C.

Fragment DNA

This step enzymatically fragments the DNA. An endpoint fragmentation is used to prevent overfragmentation.

Consumables

- ▶ FMS
- ▶ Cap mats

Preparation

- 1 Preheat the heat block with the midi plate insert to 37° C.
- 2 Prepare the following consumable:

Item	Storage	Instructions
FMS	-25°C to -15°C	Thaw at room temperature. Invert 10 times to mix, and then pulse centrifuge.

- 3 Remove the MSA6 plate from the Illumina Hybridization Oven.

Procedure

- 1 Pulse centrifuge the plate at 280 × g.
- 2 Carefully remove the cap mat.
- 3 Add 50 µl FMS to each well of the MSA6 plate.
- 4 Reseal with the cap mat using the original orientation.
- 5 Vortex at 1600 rpm for 1 minute, and then centrifuge at 280 × g for 1 minute.
- 6 Incubate on the preheated heat block for 1 hour.
If you are continuing, you can leave the plates on the heat block until you have completed preparation for the next step, no longer than 2 hours.

SAFE STOPPING POINT

If you are stopping, seal the plate, and store at -25°C to -15°C for up to 24 hours.
Store RA1 at -25°C to -15°C.

Precipitate DNA

This step uses 100% 2-propanol and PM1 to precipitate the DNA.

Consumables

- ▶ 100% 2-propanol
- ▶ PM1
- ▶ Cap mats

Preparation

- 1 Do one of the following:
 - ▶ If proceeding immediately from *Fragment DNA*, leave the MSA6 plate on the heat block until preparation is complete.
 - ▶ If the MSA6 plate was stored at -25°C to -15°C, thaw at room temperature, pulse centrifuge at 280 × g, and preheat the heat block to 37°C.
- 2 Prepare the following consumables:

Item	Storage	Instructions
PM1	2°C to 8°C	Thaw at room temperature and invert to mix. Centrifuge at 280 × g for 1 minute.

- Remove the cap mat.

Procedure

- Add 100 µl PM1 to each well of the MSA6 plate.
- Reseal with the cap mat using the original orientation.
- Vortex the plate at 1600 rpm for 1 minute.
- Incubate on the preheated heat block for 5 minutes.
- Pulse centrifuge at 280 × g for 1 minute.
- Set the centrifuge at 4°C in preparation for the next centrifuge step.
- Remove and discard the cap mat.
- Add 300 µl 100% 2-propanol to each sample well.
- Carefully seal with a **new, dry** cap mat. Avoid shaking the plate until the cap mat is seated.
- Invert the plate 10 times to mix.
- Incubate in a refrigerator set at 4°C for 30 minutes.
- Centrifuge at 3000 × g at 4°C for 20 minutes.
- Immediately remove the plate from the centrifuge.
 - ▶ When centrifuging is complete, proceed **immediately** to avoid dislodging the blue pellets.
 - ▶ If a delay occurs, repeat the 20 minute centrifuge.
- Make sure that a blue pellet is present in the bottom of each sample well.
- Remove and discard the cap mat.
- Hold the plate over an absorbent pad and do as follows.
 - Quickly invert to decant the supernatant.
 - Drain liquid onto the absorbent pad, and then smack the plate down on a dry area of the pad.
- Keeping the plate inverted, firmly tap until all wells are free of liquid (~1 minute). Do not allow supernatant to pour in to other wells.
- Place the uncovered, inverted plate on the tube rack for 1 hour at room temperature to air-dry the pellets.
- Make sure that a blue pellet is still present in the bottom of each sample well.
- Keeping the plate inverted, use a Kimwipe to remove any residual alcohol draining from the wells of the plate or remaining on the surface of the plate.

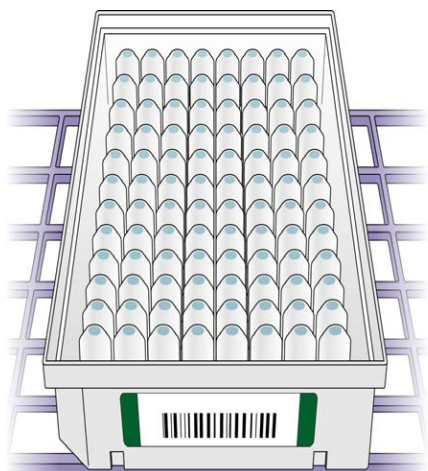

CAUTION

Do not overdry the pellets. Pellets that are overdried are difficult to resuspend and can lead to poor data quality.

SAFE STOPPING POINT

If you are stopping, seal the plate, and store at -25°C to -15°C for up to 24 hours.

Store RA1 at -25°C to -15°C .

Resuspend DNA

This step uses RA1 to resuspend the precipitated DNA.

Consumable

- ▶ RA1
- ▶ Foil heat seals

About Reagents

- ▶ Dispense only the volume necessary for each step. The *Extend and Stain BeadChips* procedure also requires RA1.
- ▶ Use fresh RA1 for each step that requires it. Properly stored RA1 that has not been dispensed for this resuspension step or the extend and stain step is considered fresh.
- ▶ RA1 might form visible precipitate or crystals. Before each use, hold in front of a light and inspect. Invert several times to redissolve the solution as needed.



WARNING

This set of reagents contains potentially hazardous chemicals. Personal injury can occur through inhalation, ingestion, skin contact, and eye contact. Wear protective equipment, including eye protection, gloves, and laboratory coat appropriate for risk of exposure. Handle used reagents as chemical waste and discard in accordance with applicable regional, national, and local laws and regulations. For additional environmental, health, and safety information, see the SDS at support.illumina.com/sds.html.

Preparation

- 1 If the MSA6 plate was stored at -25°C to -15°C, thaw at room temperature, and then remove the cap mats.
- 2 Prepare the following consumable:

Item	Storage	Instructions
RA1	-25°C to -15°C	Thaw at room temperature and invert to mix.

- 3 Preheat the Illumina Hybridization Oven to 48°C.
- 4 Preheat the heat sealer for at least 20 minutes before use.

Procedure

- 1 Add 46 µl RA1 to each well of the MSA6 plate.
- 2 With the dull side facing down, apply a foil heat seal to the plate. Hold the heat sealer sealing block down firmly and evenly for 5 seconds.
- 3 Incubate in the Illumina Hybridization Oven for 1 hour.
- 4 Vortex at 1800 rpm for 1 minute.
- 5 Pulse centrifuge at 280 × g.
- 6 Repeat steps 4 and 5 as needed to resuspend the pellets.
- 7 **[Optional]** Unless you are stopping, you can set aside the MSA6 plate for up to 1 hour before proceeding.

SAFE STOPPING POINT

If you are stopping, seal the plate, and store at -25°C to -15°C for up to 24 hours.
Store RA1 at -25°C to -15°C.

Hybridize DNA to the BeadChip

This step dispenses the fragmented, resuspended DNA onto BeadChips. Incubation then hybridizes each DNA sample to a section of the BeadChip.

Consumables

- ▶ 100% EtOH (Ethanol)
- ▶ PB2
- ▶ XC4

About Reagents

- ▶ Keep XC4 in the original bottle until you are ready to use it.
- ▶ Each XC4 bottle contains sufficient reagent to process up to 24 BeadChips.
- ▶ Use resuspended XC4 at room temperature.

Preparation

- 1 If frozen, thaw the MSA6 plate at room temperature, and then pulse centrifuge at 280 × g.

- 2 Preheat the heat block to 95°C.
- 3 Preheat the Illumina Hybridization Oven to 48°C.

Procedure

Denature DNA

- 1 Place the MSA6 plate on the preheated heat block for 20 minutes to denature the DNA.
- 2 Cool the MSA6 plate on the benchtop at room temperature for 30 minutes.
- 3 Pulse centrifuge at 280 × g.

Assemble the Hybridization Chambers

Assemble one chamber for every four BeadChips by following the steps in this section.

- 1 Place the hybridization chambers, hybridization chamber gaskets, and hybridization chamber inserts on the benchtop.

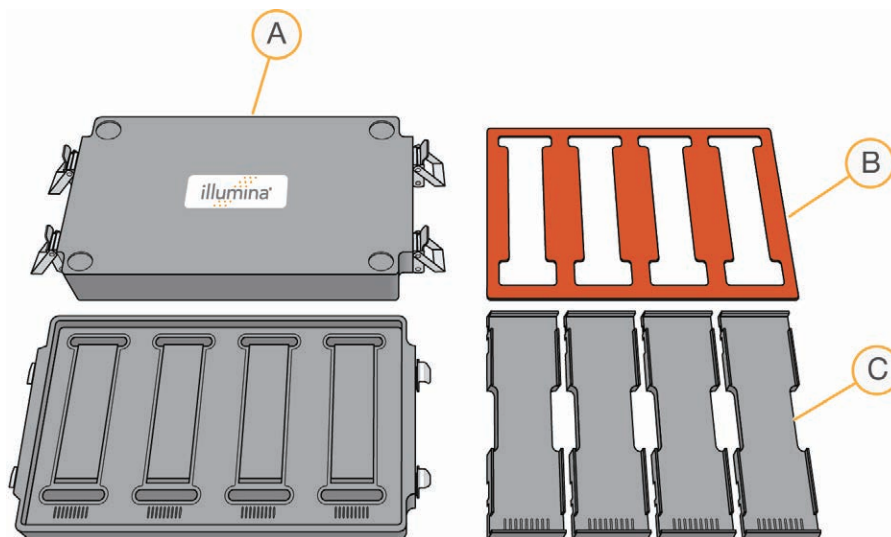

- A Hybridization chambers
- B Hybridization chamber gaskets
- C Hybridization chamber inserts

- 2 Align the wider edge of the gasket to the barcode ridges.

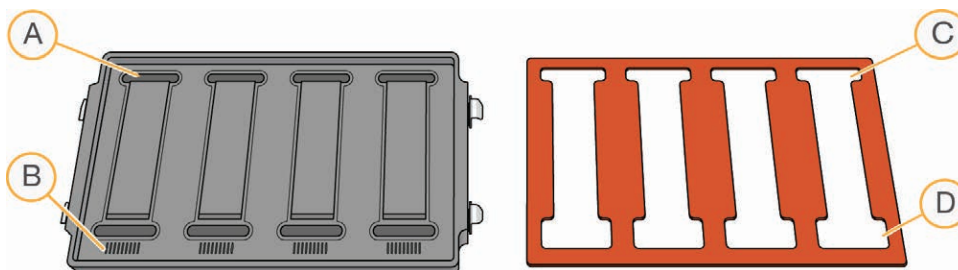

- A Reagent reservoirs

- B Barcode ridges
- C Narrower gasket edges
- D Wider gasket edges

- 3 Place the gasket into the hybridization chamber.
 - ▶ Match the wider edge of the hybridization chamber gasket to the barcode-ridge side of the hybridization chamber.
 - ▶ Press down on the edges of the gasket to make sure it is properly seated.



- 4 Make sure that the gaskets are properly placed and seated.

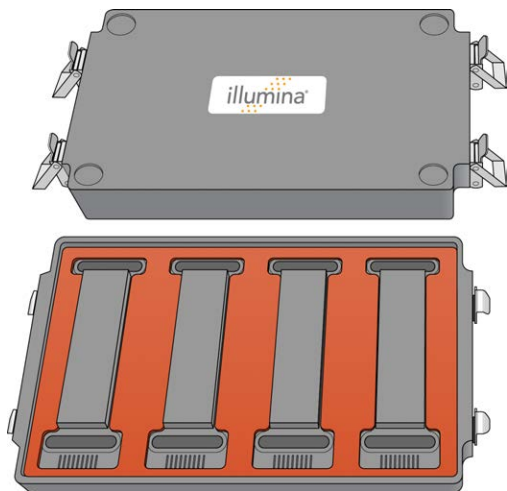

- 5 Add 400 μ l PB2 to the top and bottom wells of each beadchip subchamber in the hybridization chamber.

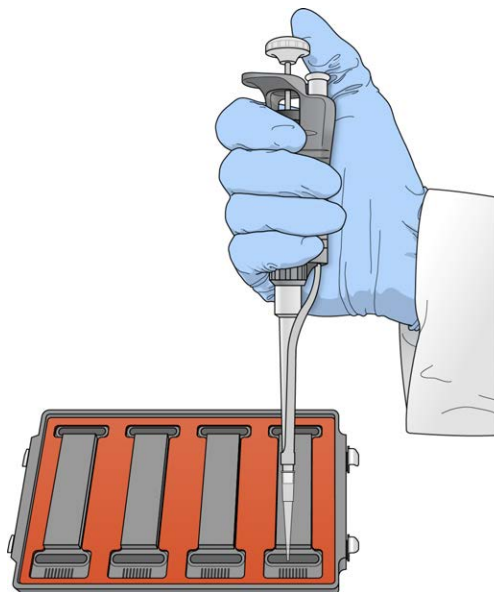

- 6 Immediately cover the chamber with the lid to prevent evaporation. Locking the lid is not necessary.
- 7 Leave the closed chambers on the benchtop at room temperature until the BeadChips are loaded with DNA (~1 hour).

Load DNA Onto BeadChips

- 1 Pulse centrifuge the MSA6 plate at 280 \times g.
- 2 Remove the BeadChips from all packaging. Hold BeadChips by the ends, away from the sample inlets.
- 3 Place each BeadChip into an insert so that the barcode ends align.

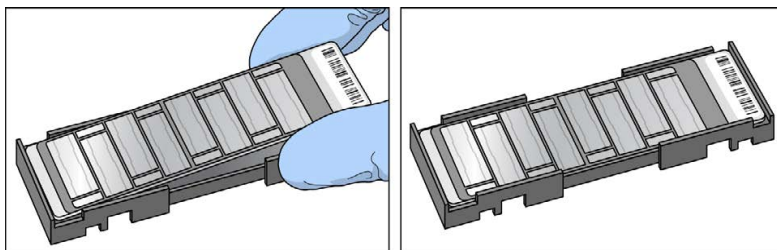

- 4 Remove the foil seal from the MSA6 plate.
- 5 Transfer 35 μ l each sample from the MSA6 plate to the appropriate section of the BeadChip.
 - ▶ Insert the pipette into the sample inlet before dispensing.
 - ▶ Load A1–H1, as shown in the following graphic.

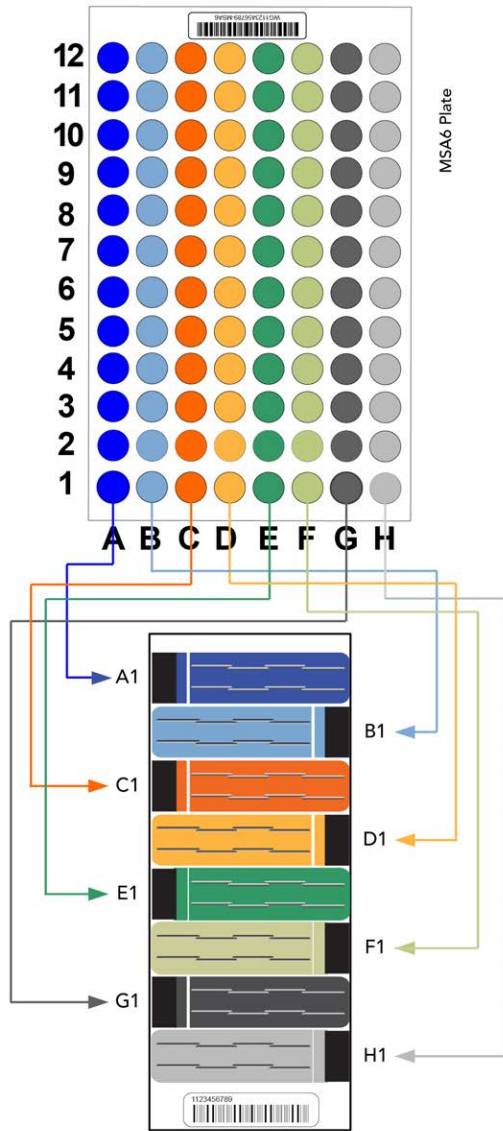

- 6 Wait for the DNA to disperse over the entire surface.
- 7 Inspect the loading port for excess liquid.

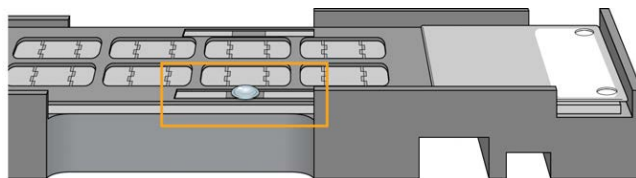

- 8 If excess liquid is not present, add leftover sample from the amplification plate to create a bolus around the loading port. Do not use RA1, which dilutes the sample. Excess liquid is desired because it prevents evaporation and the creation of low-intensity areas.

Set Up BeadChips for Hybridization

- 1 Load the inserts containing BeadChips into the hybridization chamber.
 - ▶ Position the barcode end over the ridges indicated on the chamber.
 - ▶ Keep the inserts steady and level.

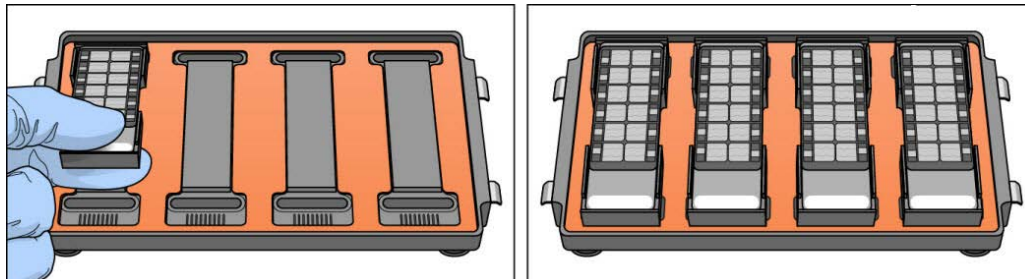

- 2 Place the back of the lid onto the chamber, and then slowly lower the front to avoid dislodging the inserts.

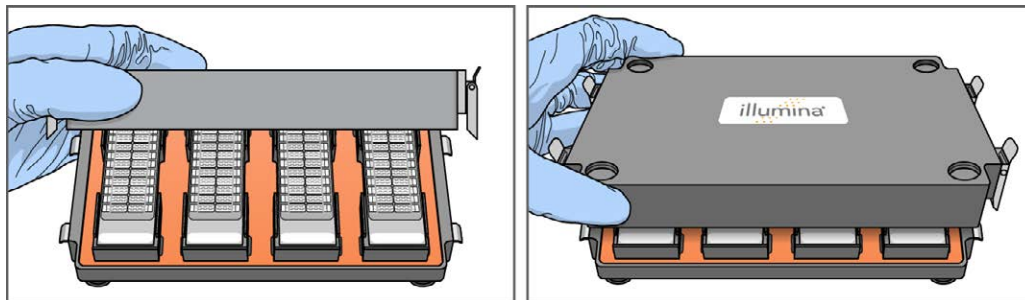

- 3 Close all four clamps so that the lid is secure and sits evenly on the base without any gaps. Close the clamps in the following order: top-left, bottom-right, top-right, bottom-left.
- 4 Place the chamber into the preheated Illumina Hybridization Oven so that the top logo faces you. You can stack up to three chambers per row for a total of six chambers. Make sure that the feet of the top chamber fit into the indents on the bottom chamber.

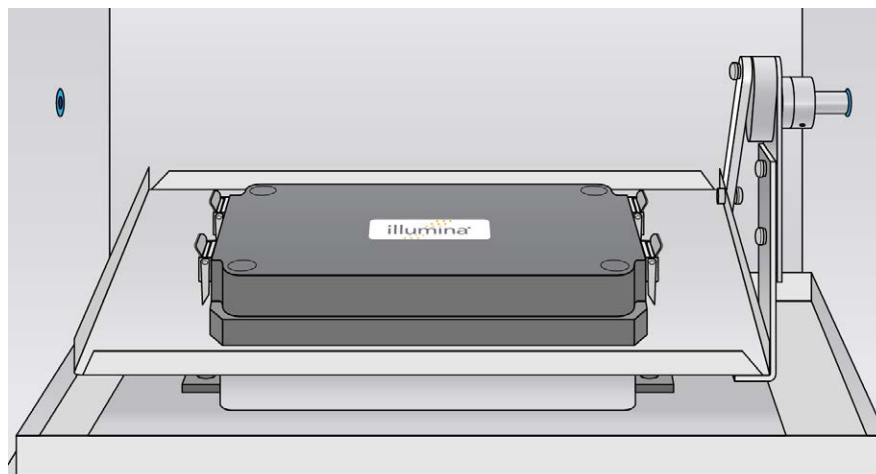

- 5 Incubate at 48°C for 16–24 hours.
- 6 Store RA1 at -25°C to -15°C for use the next day.

Resuspend XC4

Resuspend XC4 to prepare for the *Extend and Stain BeadChips* step.

- 1 Add 330 ml fresh 100% EtOH to the XC4 bottle.
The resulting volume is ~ 350 ml.
- 2 Vigorously shake to resuspend.
- 3 Leave the bottle upright on the lab bench overnight.
- 4 **[Optional]** Store at 2°C to 8°C and use up to six times over a period of 2 weeks.

Wash BeadChips

This step prepares the BeadChips for the staining process.

Consumables

- ▶ 95% Formamide/1 mM EDTA
- ▶ ATM
- ▶ EML
- ▶ PB1
- ▶ ATM
- ▶ SML
- ▶ LX1
- ▶ LX2
- ▶ XC3
- ▶ XC4

About Reagents

- ▶ Decant only the reagent volume needed for each step. Some reagents are needed later in the protocol.
- ▶ Excepting PB1, all reagents are prepared in this step for use in a subsequent step.



WARNING

This set of reagents contains potentially hazardous chemicals. Personal injury can occur through inhalation, ingestion, skin contact, and eye contact. Wear protective equipment, including eye protection, gloves, and laboratory coat appropriate for risk of exposure. Handle used reagents as chemical waste and discard in accordance with applicable regional, national, and local laws and regulations. For additional environmental, health, and safety information, see the SDS at support.illumina.com/sds.html.

Preparation

- 1 Remove each hybridization chamber from the hybridization oven. Allow to cool for 30 minutes before opening.
- 2 Prepare the following items:
 - ▶ Fill two wash dishes with 200 ml PB1 each and label them Wash 1 and Wash 2.
 - ▶ Using a graduated cylinder, fill the Multi-Sample BeadChip Alignment Fixture with 150 ml PB1.

3 Remove the following Te-Flow flow-through chamber components from storage:

- ▶ Black frames
- ▶ Spacers (separated for ease of handling)
- ▶ Clean glass back plates
- ▶ Clamps

4 Prepare the following consumables for the subsequent *Extend and Stain BeadChips* step:

Item	Storage	Instructions
95% Formamide/1mM EDTA	-25°C to -15°C	Thaw at room temperature. Invert 10 times to mix.
ATM	-25°C to -15°C	Thaw at room temperature. Invert 10 times to mix.
EML	-25°C to -15°C	Thaw at room temperature. Invert 10 times to mix.
PB1	Room temperature	Thaw at room temperature. Invert 10 times to mix.
RA1	-25°C to -15°C	Shake vigorously to resuspend. If necessary, vortex until dissolved.
SML	-25°C to -15°C	Thaw at room temperature. Invert 10 times to mix.
LX1	-25°C to -15°C	Thaw at room temperature. Invert 10 times to mix.
LX2	-25°C to -15°C	Thaw at room temperature. Invert 10 times to mix.
XC3	Room temperature	Thaw at room temperature. Invert 10 times to mix.
XC4	Room temperature	Thaw at room temperature. Invert 10 times to mix.

Procedure

Wash BeadChips

1 Attach the wire handle and submerge the wash rack in Wash 1 containing 200 ml PB1.



CAUTION

Replace PB1 in Wash 1 after every 12 BeadChips.



2 Remove the hybridization insert from the hybridization chambers.

- 3 Remove the BeadChips from the hybridization insert.
- 4 Remove the cover seals from the BeadChips.
Using powder-free gloved hands, hold the BeadChip securely and by the edges in one hand. Remove the entire seal in a single, continuous motion. Do not touch exposed arrays.

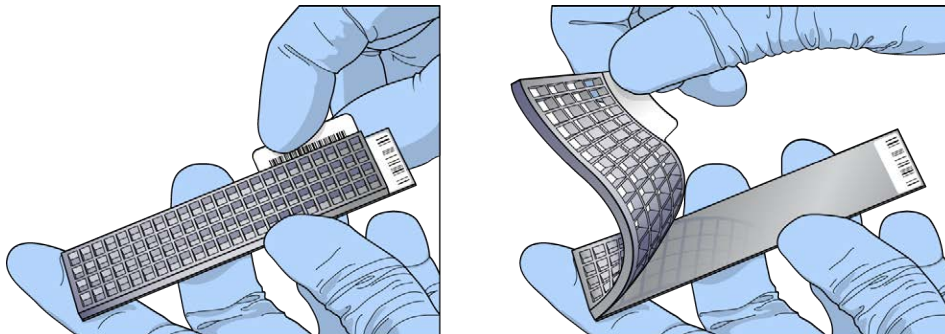

- 5 Immediately and carefully slide each BeadChip into the wash rack in Wash 1. Make sure that the BeadChip is submerged in PB1.
- 6 Repeat steps 4–5 until all BeadChips are transferred to the submerged wash rack in Wash 1.
- 7 Move the wash rack up and down for 1 minute. Break the surface of the PB1 with gentle, slow agitation.
- 8 Move the wash rack to Wash 2 containing clean PB1. Make sure that the BeadChips are submerged.
- 9 Move the wash rack up and down for 1 minute. Break the surface of the PB1 with gentle, slow agitation.
- 10 Remove the BeadChips from the wash rack and inspect them for remaining residue.
If you see residue, submerge the BeadChip in PB1 and carefully use a pipette tip to remove the remaining residue.

Assemble Flow-Through Chambers

- 1 Confirm that you are using the correct Infinium LCG glass back plates and spacers before proceeding.

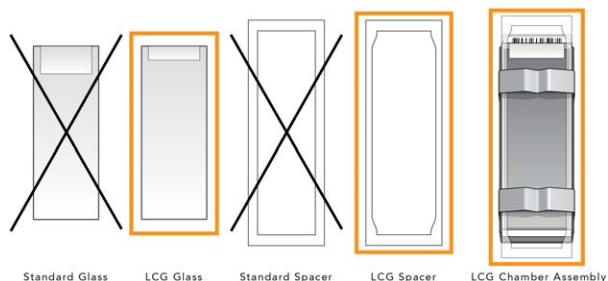

- 2 Fill the BeadChip alignment fixture with 150 ml PB1.
- 3 For each BeadChip, place one black frame into the BeadChip alignment fixture.
For example, if you are processing four BeadChips, place four black frames into the fixture.



- 4 Place each BeadChip into a black frame, aligning the barcode with the alignment fixture ridges. Fully submerge each BeadChip.



- 5 Place a *clear* spacer onto the top of each BeadChip. Use the alignment fixture grooves to guide the spacers into position.
The white spacers are not a substitute for the clear spacers.



- 6 Place the alignment bar onto the alignment fixture. Fit the groove on the alignment bar over the tab on the alignment fixture.

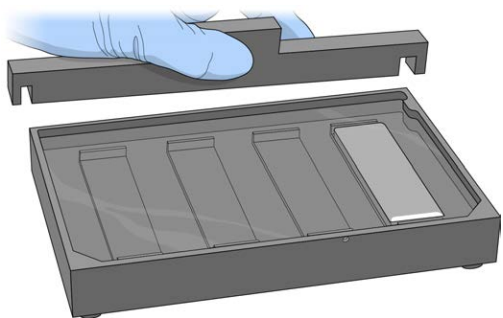

- 7 Place a clean glass back plate on top of each clear spacer. Position the plate reservoir at the barcode end of the BeadChip, facing inward to create a reservoir against the BeadChip surface.

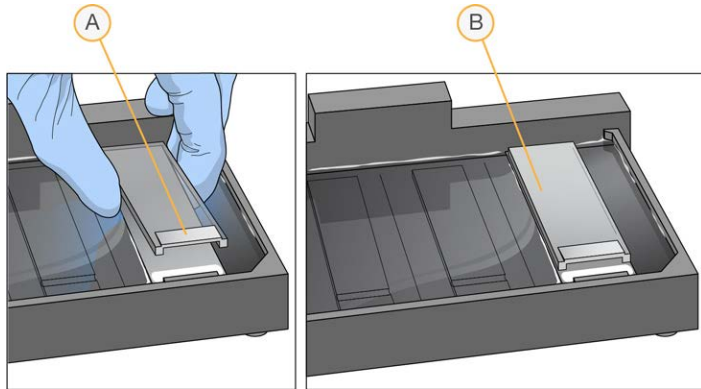

- A Reservoir at the barcode end of the glass back plate.
- B Glass back plate in position.

- 8 Secure each flow-through chamber assembly with metal clamps as follows.
- a Using one finger, gently push the glass back plate against the alignment bar.
 - b Place a metal clamp around the flow-through chamber 5 mm from the top edge.
 - c Place a second metal clamp around the flow-through chamber at the barcode end, 5 mm from the bottom of the reagent reservoir.

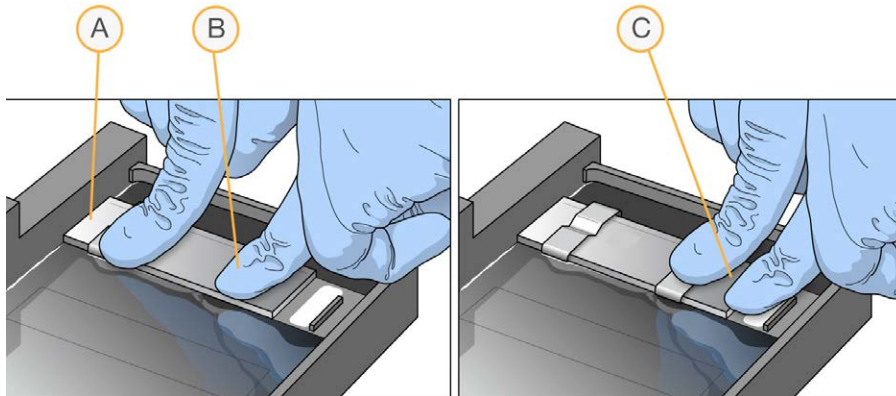

- A One stripe is visible between the first clamp and the alignment bar.
- B Glass back plate pressed against the alignment bar.
- C Stripes are not visible between the second clamp and the barcode.

- 9 Remove the assembled flow-through chamber from the alignment fixture.

- 10 Starting at the nonbarcode end, trim the spacers from each end of the assembly using scissors.

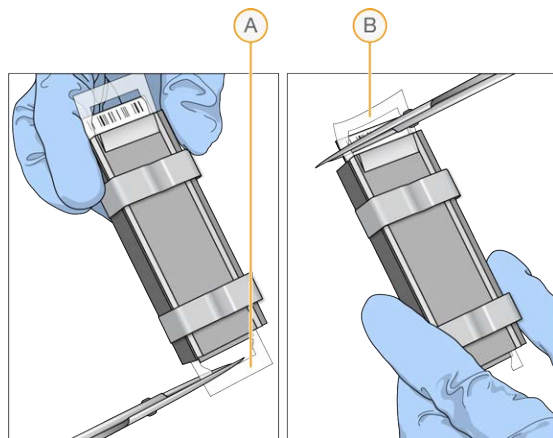

- A Trimming the spacer at the nonbarcode end.
 B Trimming the spacer at the barcode end.

- 11 Leave assembled flow-through chambers on the lab bench in a horizontal position until ready to load onto chamber rack in the *Extend and Stain BeadChips* step.
- ▶ Do not place on absorbent paper.
 - ▶ Do not place in the chamber rack until instructed to do so.
- 12 Wash the hybridization chamber reservoirs with DI H₂O.
 Immediate and thorough washing ensures complete removal of PB1 from the wells.

Extend and Stain BeadChips

This step washes unhybridized and nonspecifically hybridized DNA samples from the BeadChips, adds labeled nucleotides to extend primers hybridized to the sample, and stains the primers. After the flow-through chambers are disassembled, the BeadChips are coated for protection.

Consumables

- ▶ 70% EtOH (Ethanol)
- ▶ 95% formamide/1 mM EDTA (10 ml for 1–4 BeadChips)
- ▶ Alconox Powder Detergent
- ▶ ATM (1 tube/4 BeadChips)
- ▶ EML (1 tube/4 BeadChips)
- ▶ PB1 (310 ml for 1–8 BeadChips, 285 ml for 9–24 BeadChips)
- ▶ RA1 (10 ml for 1–8 BeadChips, 20 ml for 9–16 BeadChips, 30 ml 17–24 BeadChips)
- ▶ SML (1 tube/4 BeadChips)
- ▶ LX1 (1 tube/4 BeadChips)
- ▶ LX2 (1 tube/4 BeadChips)
- ▶ XC3 (50 ml for 1–8 BeadChips, 100 ml for 9–16 BeadChips, 150 ml for 17–24 BeadChips)
- ▶ XC4 (310 ml for 1–8 BeadChips, 285 ml for 9–24 BeadChips)

About Reagents

- ▶ Make sure that the label of each SML tube indicates the same stain temperature.
- ▶ Decant only the necessary volume of reagent.
- ▶ Use fresh RA1 for each step that requires it. Properly stored RA1 that has not been dispensed for the previous resuspension step or this extend and stain step is considered fresh.
- ▶ RA1 might form visible precipitate or crystals. Before each use, hold in front of a light and inspect. Invert several times to redissolve the solution as needed.
- ▶ The XC4 coat is slippery and makes the BeadChips difficult to hold. Self-locking tweezers grip the BeadChip firmly and help prevent damage.



WARNING

This set of reagents contains potentially hazardous chemicals. Personal injury can occur through inhalation, ingestion, skin contact, and eye contact. Wear protective equipment, including eye protection, gloves, and laboratory coat appropriate for risk of exposure. Handle used reagents as chemical waste and discard in accordance with applicable regional, national, and local laws and regulations. For additional environmental, health, and safety information, see the SDS at support.illumina.com/sds.html.

Preparation

- 1 Prepare the following consumable:

Item	Storage	Instructions
RA1	-25°C to -15°C	Thaw at room temperature.

- 2 Place reagent tubes in a rack in the order of use: LX1, LX2, EML, 95% Formamide / 1mM EDTA, SML, ATM.

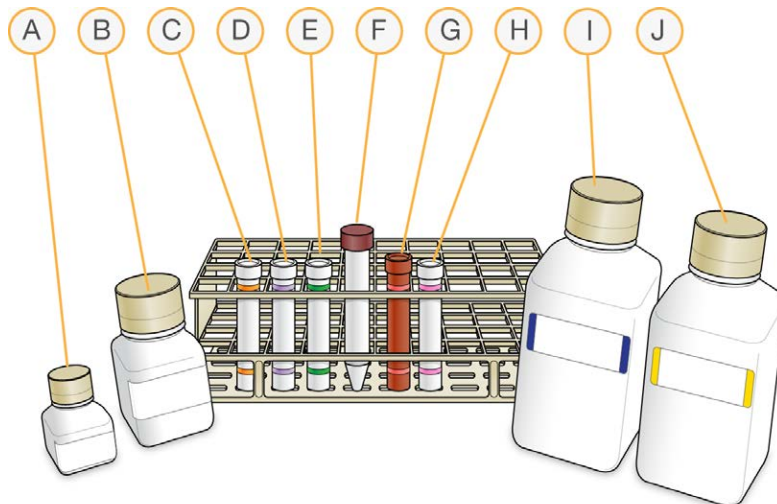

- A RA1
- B XC3
- C LX1
- D LX2
- E EML

- F 95% Formamide / 1mM EDTA
- G SML
- H ATM
- I PB1
- J XC4

Procedure

Set Up the Chamber Rack

- 1 Make sure that the water circulator is filled to the appropriate level. See the *VWR Operator Manual*, VWR part # 110-229.
- 2 Turn on the water circulator. Set it to a temperature that brings the Chamber Rack to 44°C at equilibrium. This temperature can vary depending on facility ambient conditions.

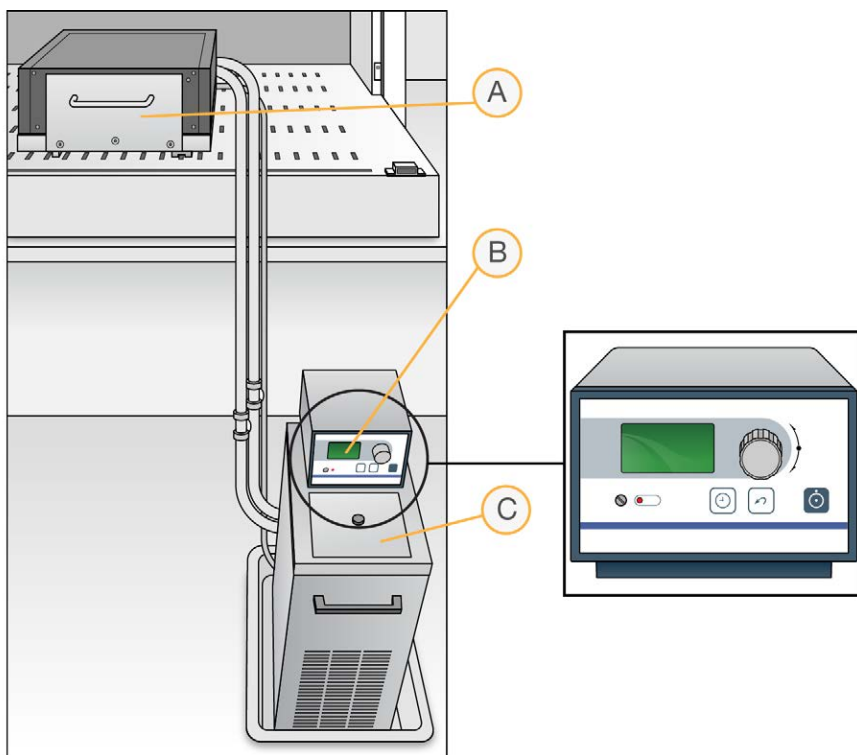

- A Chamber rack
- B Water circulator with programmable temperature controls
- C Reservoir cover

- 3 Confirm the actual temperature using the chamber rack temperature probe. The temperature displayed on the water circulator screen can differ from the chamber rack temperature.
- 4 Remove bubbles trapped in the chamber rack.
 - a Separate the heat exchanger from the reagent pan.
 - b Lift the heat exchanger upright and away from you with the tubing at the bottom, and turn 90° counter clockwise.

- c Return the heat exchanger to a horizontal position.
 - d Repeat steps b and c 3 times for a total of 4 rotations or until all bubbles are removed.
 - e Using Kimwipes dampened with laboratory-grade water, clean all surfaces between the heat exchanger and reagent pan. Discard Kimwipes with formamide waste.
 - f Place the Te-Flow back on the reagent pan. Using the two guide pins in the reagent pan, make sure that the Te-Flow is flush.
- 5 Using the Illumina temperature probe, test at least three locations on the chamber rack.
- a For accurate measurements, make sure that the temperature probe touches the base of the chamber rack.
 - b Make sure that all locations are at $44^{\circ}\text{C} \pm 0.5^{\circ}\text{C}$.
 - c If the temperature is not within $\pm 0.5^{\circ}\text{C}$, adjust the water circulator control knob to reach $44^{\circ}\text{C} \pm 0.5^{\circ}\text{C}$.
 - d Do not leave the temperature probe in the first three rows of the chamber rack. Reserve these rows for BeadChips.

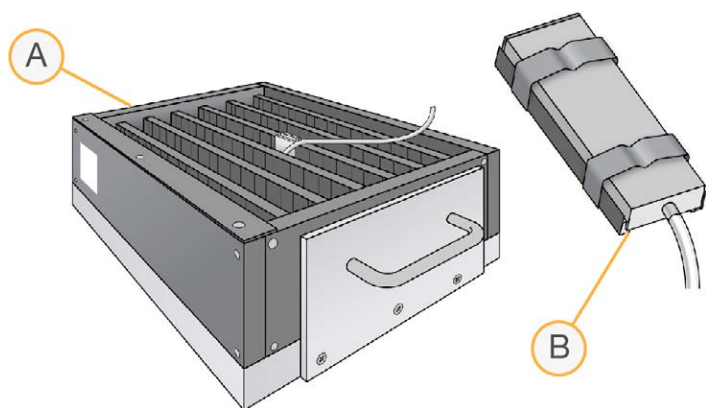

A Chamber rack with temperature probe
 B Temperature probe

Single-Base Extension

- 1 When the chamber rack reaches 44°C , quickly place the flow-through chamber assemblies into the chamber rack.



CAUTION

To avoid assay failure, complete this procedure without interruption.

- 2 Make sure that each flow-through chamber is properly seated on the rack to allow adequate heat exchange between the rack and the chamber.
- 3 Without allowing pipette tips to touch BeadChip surfaces, fill the reservoir of each flow-through chamber as follows.
 - a $150\ \mu\text{l}$ RA1. Incubate for 30 seconds. Repeat 5 times.
 - b $225\ \mu\text{l}$ LX1. Repeat 1 time. Incubate for 10 minutes.
 - c $225\ \mu\text{l}$ LX2. Repeat 1 time. Incubate for 10 minutes.
 - d $300\ \mu\text{l}$ EML. Incubate for 15 minutes.
 - e $250\ \mu\text{l}$ 95% formamide/1 mM EDTA. Incubate for 1 minute. Repeat twice.

- f Incubate 5 minutes.
- g Set the chamber rack temperature to the temperature indicated on the SML tube.
- h 250 μ l XC3. Incubate for 1 minute. Repeat twice.

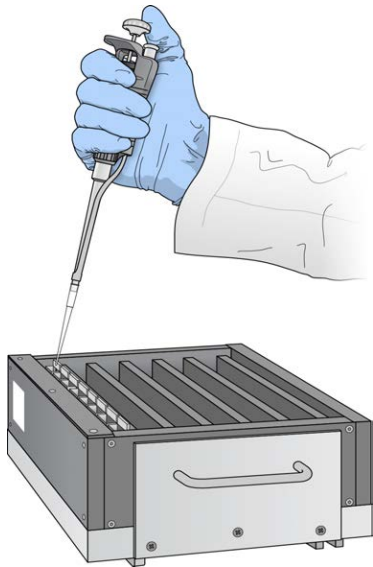

- 4 Wait for the chamber rack to reach the correct temperature.

Stain BeadChips

- 1 If you are imaging the BeadChip immediately after the staining process, turn on the scanner to allow the lasers to stabilize.
- 2 Fill the reservoir of each flow-through chamber as follows.
 - a 250 μ l SML. Incubate for 10 minutes.
 - b 250 μ l XC3. Incubate for 1 minute. Repeat twice.
 - c Wait 5 minutes.
 - d 250 μ l ATM. Incubate for 10 minutes.
 - e 250 μ l XC3. Incubate for 1 minute. Repeat twice.
 - f Wait 5 minutes.
 - g 250 μ l SML. Incubate for 10 minutes.
 - h 250 μ l XC3. Incubate for 1 minute. Repeat twice.
 - i 250 μ l ATM. Incubate for 10 minutes.
 - j 250 μ l XC3. Incubate for 1 minute. Repeat twice.
 - k Wait 5 minutes.
 - l 250 μ l SML. Incubate for 10 minutes.
 - m 250 μ l XC3. Incubate for 1 minute. Repeat twice.
 - n Wait 5 minutes.
- 3 Immediately remove the flow-through chambers from the chamber rack and place in reserved alignment fixtures submerged in PB1 at room temperature on a lab bench.

Wash and Coat BeadChips

- 1 Gather the following equipment:
 - ▶ Kimwipes, large
 - ▶ Staining rack
 - ▶ Self-locking tweezers
 - ▶ Tube rack
 - ▶ Vacuum desiccator
 - ▶ Vacuum hose
 - ▶ Wash dishes (2)
- 2 During the procedure, prevent dust or lint from entering the wash dishes.
 - ▶ Clean wash dishes with low-pressure air before use.
 - ▶ Cover wash dishes with wash dish covers when not in use.
- 3 Wash the tube racks and wash dishes thoroughly after each use.
 - ▶ Rinse with deionized water.
 - ▶ Dry racks and wash dishes upside down on a wash rack.
- 4 Place a clean tube rack on top of several layers of Kimwipes or an absorbent pad. After the staining rack containing BeadChips is removed from the XC4 wash dish, it is placed on this rack.
- 5 Prepare another clean tube rack that fits the internal dimensions of vacuum desiccator for removal of the BeadChips. Allow one rack per eight BeadChips. Kimwipes are not needed under this tube rack.
- 6 Set up two top-loading wash dishes labeled PB1 and XC4.
- 7 To indicate fill volume of each wash dish:
 - a Add 310 ml water.
 - b Mark the water level on the side.
 - c Empty the water.

Indicating fill volume before adding reagents allows reagents to be added directly from the bottles, minimizing contamination.

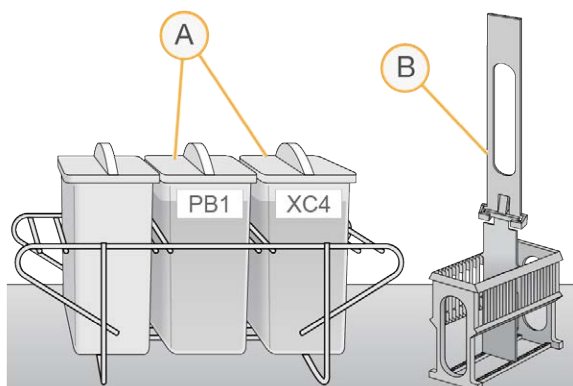

- A Labeled and filled wash dishes
- B Staining rack

- 8 Add 310 ml PB1 to the PB1 wash dish.

- 9 Submerge the staining rack in the wash dish so that the locking arms and tab **face you**. This orientation ensures that you can safely remove the BeadChips.

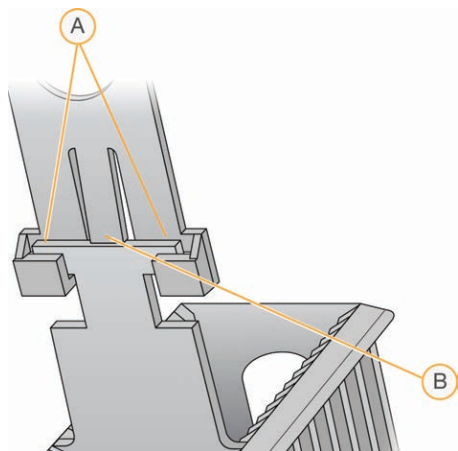

- A Locking arms
- B Tab

- 10 Leave the staining rack in the wash dish for later use (carrying the BeadChips after disassembling the flow-through chambers).
- 11 **Using the dismantling tool**, remove the two metal clamps from a flow-through chamber. The dismantling tool prevents chipping the glass back plates.

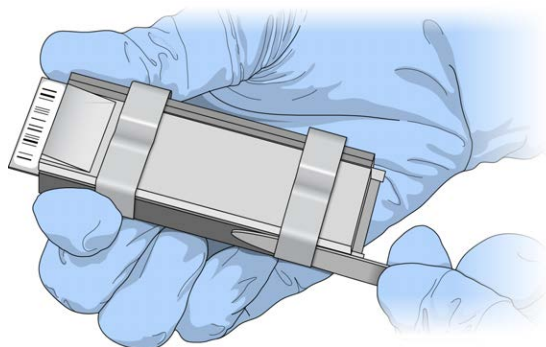

- 12 Lift the glass back plate straight up to remove. Set aside for cleaning after finishing this procedure. Sliding the glass along the BeadChip can damage the BeadChip.
- 13 Remove the spacer, avoiding contact with the BeadChip stripes.
- 14 Remove the BeadChip from the black frame. Handle the BeadChip only by the barcode end or edges.
- 15 Repeat steps 11–14 to disassemble each flow-through chamber one at a time.
- 16 Place the BeadChips into the submerged staining rack. Make sure that the BeadChip barcodes face **away** from you and the locking arms face **toward** you.



CAUTION

Submerge each BeadChip as quickly as possible to prevent drying.

- 17 If necessary to seat a BeadChip, briefly lift the staining rack from the wash dish and seat the BeadChip.
- 18 Make sure that the BeadChips are submerged.

- 19 Slowly move the staining rack up and down 10 times, breaking the PB1 surface. If the tops of the BeadChips touch, gently wiggle the staining rack to separate the slides. Free circulation of PB1 between BeadChips is important.

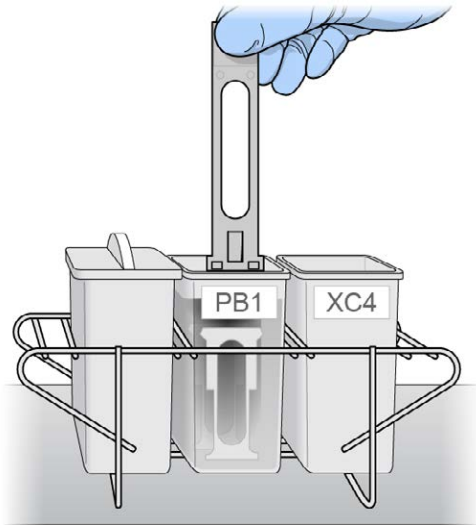

- 20 Soak for 5 minutes.
- 21 Vigorously shake the XC4 bottle to resuspend completely. If necessary, vortex until dissolved.
- 22 Add 310 ml XC4 to the XC4 wash dish.
- ▶ Cover to prevent lint or dust from entering.
 - ▶ Do not let sit for more than 10 minutes.
- 23 Transfer the staining rack from the PB1 wash dish to the XC4 wash dish.

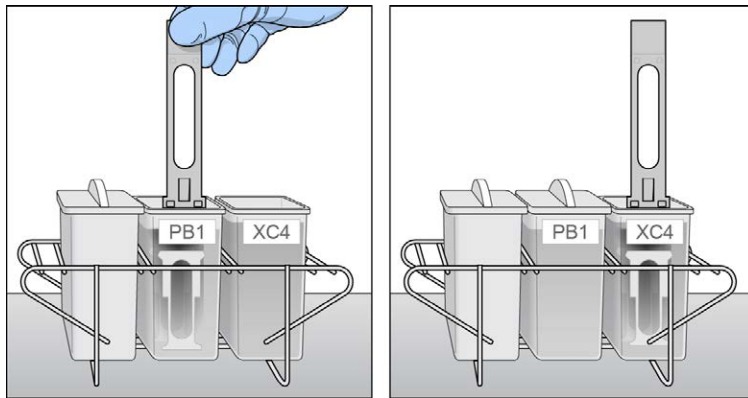

- 24 Slowly lift the staining rack up and down 10 times, breaking the XC4 surface. If the tops of the BeadChips touch, gently wiggle the staining rack to separate the slides.
- 25 Soak for 5 minutes.
- 26 Remove the staining rack in one quick motion and place it onto the prepared tube rack.

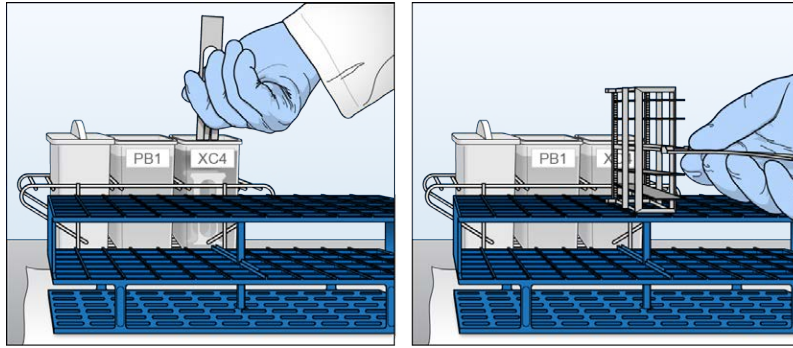

27 Make sure that the staining rack is in the center of the tube rack to ensure uniform coating. Avoid the raised edges.

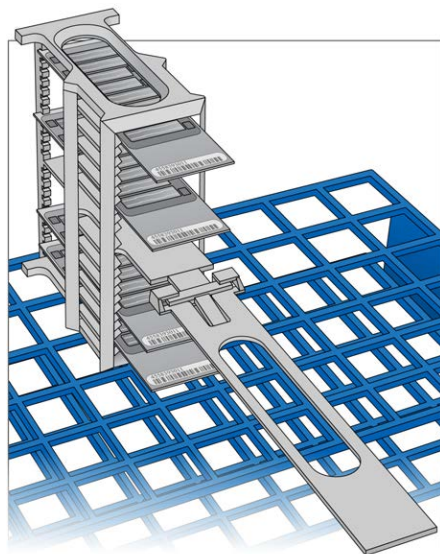

28 **[Optional]** Remove the staining rack handle to facilitate BeadChip removal:

- a Holding the top of the staining rack in position, grasp the handle between your thumb and forefinger.
- b Push up the tab with your thumb and push the handle away from you, unlocking the handle.
- c Pull up the handle and remove.

29 For each BeadChip, working top to bottom:

- a Holding the staining rack handle (if present), use self-locking tweezers to grip the BeadChip by the barcode end.
- b Place the BeadChip onto a tube rack with the barcode facing up and toward you. Do not place on the bottom rack or allow BeadChips to rest on the tube rack edge or touch each other.

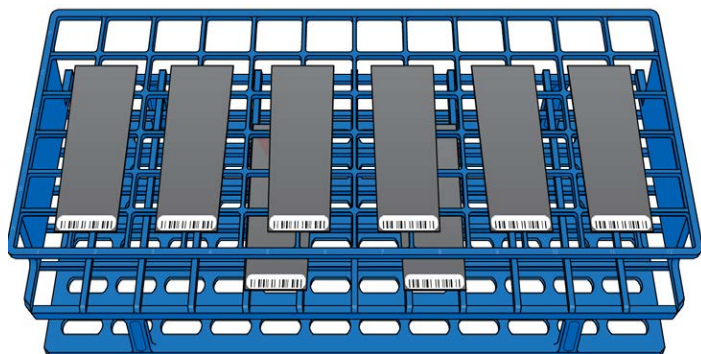

Proper BeadChip placement prevents wicking, uneven drying, and pooled dye protectant.

- 30 Place the tube rack into the vacuum desiccator.
Each desiccator can hold one tube rack (eight BeadChips).
- 31 Make sure that the vacuum desiccator valve is seated tightly and securely, and remove the red plug from the three-way valve.
- 32 Gently lift the vacuum desiccator lid to ensure proper sealing. Make sure that the lid does not lift off the desiccator base.
- 33 Dry the BeadChips in the vacuum desiccator for 50–55 minutes at 675 mm Hg (0.9 bar).
Drying times can vary according to room temperature and humidity.
- 34 Release the vacuum by turning the handle slowly.



WARNING

Make sure that air enters the desiccator very slowly to avoid disturbing the contents. Improper use of the vacuum desiccator can result in damage to the BeadChips, especially if you remove the valve plug while a vacuum is applied. For detailed vacuum desiccator instructions, see the documentation included with the desiccator.

- 35 Return the desiccator to storage. Store with the red valve plug in the three-way valve of the desiccator to prevent dust and lint from accumulating in the valve port.
- 36 Touch the edges of the BeadChips (**do not touch arrays**) to make sure etched, barcoded sides are dry.
- 37 Clean the back of each BeadChip using a Kimwipe sprayed with 70% EtOH:
 - a Hold the BeadChip at a downward angle to prevent excess EtOH from dripping onto the stripes.
 - b Without touching the stripes, wipe the underside of the BeadChip until XC4 is removed (5–6 times).
- 38 Clean the glass back plates.
For instructions, see the *Infinium Assay Lab Setup and Procedures Guide* (document # 11322460).

SAFE STOPPING POINT

Store the BeadChips in the Illumina BeadChip Slide Storage Box at room temperature. Scan within 72 hours.

Image BeadChip

Follow the instructions in the System Guide for your instrument to scan your BeadChips.

Use the **Infinium LCG** scan setting for your BeadChip.

Illumina GenomeStudio

The Illumina GenomeStudio Genotyping Module, included with your Illumina Infinium Assay system, is an application for extracting genotyping data from intensity data files (*.idat files) collected from your Illumina scanning instrument.

For feature descriptions and instructions on using the GenomeStudio platform to visualize and analyze genotyping data, see the *GenomeStudio Framework User Guide* and the *GenomeStudio Genotyping User Guide*.

Chapter 3 Automated Protocol

Introduction	40
Infinium LCG Automated Workflow	40
Quantify DNA (Optional)	42
Amplify DNA	46
Incubate DNA	48
Fragment DNA	48
Precipitate DNA	49
Resuspend DNA	52
Hybridize DNA to the BeadChip	53
Wash BeadChips	59
Extend and Stain BeadChips	64
Image BeadChip	73
Illumina GenomeStudio	74

Introduction

This section describes pre- and post-amplification automated laboratory protocols for the Infinium LCG Assay both with and without using the Illumina Laboratory Information Management System (LIMS) to track barcodes and other project information. Follow the protocols in the order shown. For information on using LIMS, see the *Illumina LIMS Software Guide (document # 1000000032951)*.

Infinium LCG Automated Workflow

The following diagram illustrates the Infinium LCG Assay automated workflow for 12 BeadChips. These protocols describe the procedure for preparing 96 DNA samples.

Figure 7 Illumina Infinium LCG Assay Automated Workflow

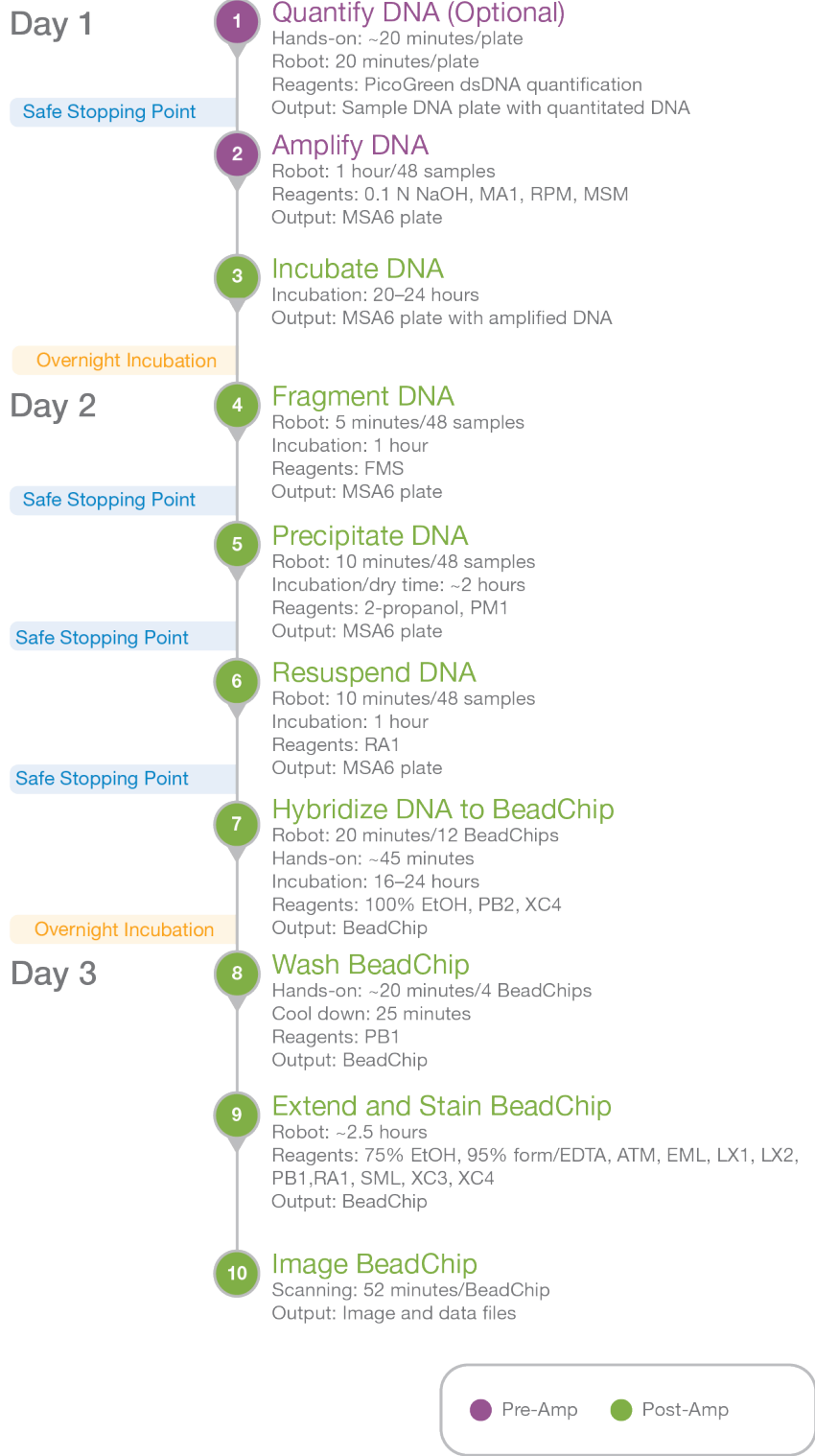

Quantify DNA (Optional)

This step uses the PicoGreen dsDNA quantification reagent to quantify double-stranded DNA samples. Quantify up to 6 plates, each containing up to 96 samples.

Consumables

- ▶ PicoGreen dsDNA quantification reagent
- ▶ 1X TE
- ▶ Lambda DNA
- ▶ 96-well 0.65 ml microplates
- ▶ FLUOTRAC 200 96-well flat-bottom plate (1 per standard DNA plate/1 per sample DNA plate)

About Reagent

- ▶ Do not use glass containers with PicoGreen. It degrades quickly in the presence of light and can adhere to glass, which lowers its effective concentration in solution and affects the upper response range accuracy.

Preparation

- 1 Prepare the following consumable:

Item	Storage	Instructions
PicoGreen dsDNA quantification reagent	2° to 8°C	Thaw at room temperature for 60 minutes in a light-impermeable container.

- 2 Label the 96-well microplate **Standard DNA**.
- 3 Label the FLUOTRAC plates **Standard QDNA** and **Sample QDNA**.
The Sample QDNA plate is for the quantified DNA.

Procedure

Make a Standard DNA Plate

This step creates a Standard DNA plate with serial dilutions of stock Lambda DNA in the wells of column 1.

- 1 Add stock Lambda DNA to well A1 in the Standard DNA plate and dilute to 75 ng/μl in a final volume of 233.3 μl. Pipette up and down several times to mix.
 - ▶ Use the following formula to calculate the amount of stock Lambda DNA:

$$\frac{(233.3 \mu\text{l}) \times (75 \text{ ng} / \mu\text{l})}{(\text{stock Lambda DNA concentration})} = \mu\text{l stock Lambda DNA to add to A1}$$
 - ▶ Dilute the stock DNA in well A1 using the following formula:

$$\mu\text{l 1X TE to add to A1} = 233.3 \mu\text{l} - \mu\text{l stock Lambda DNA in well A1}$$
- 2 Add 66.7 μl 1X TE to well B1.
- 3 Add 100 μl 1X TE to the remaining wells of column 1.

Figure 8 Dilution of Stock Lambda DNA Standard

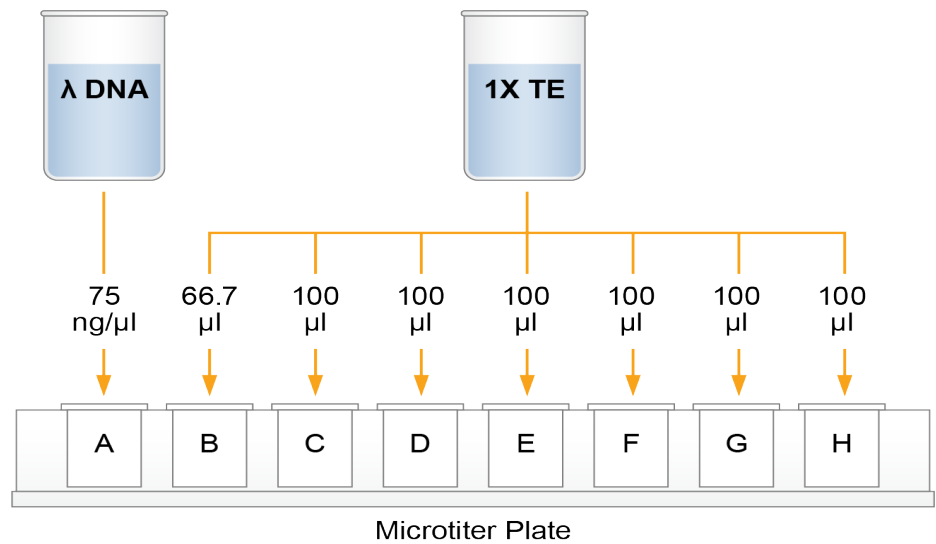

- 4 Transfer 133.3 μ l Lambda DNA from well A1 to well B1. Pipette up and down several times to mix.
- 5 Transfer 100 μ l from well B1 to well C1. Pipette up and down several times to mix.
- 6 Repeat the sequential transfer of 100 μ l for wells D1, E1, F1, and G1. **Do not transfer from well G1 to H1.** Well H1 serves as the blank 0 ng/ μ l Lambda DNA.

Table 2 Concentrations of Lambda DNA

Row-Column	Concentration (ng/ μ l)	Final Volume in Well (μ l)
A1	75	100
B1	50	100
C1	25	100
D1	12.5	100
E1	6.25	100
F1	3.125	100
G1	1.5262	200
H1	0	100

Figure 9 Serial Dilutions of Lambda DNA
Standard DNA Plate with Serial Dilutions of Stock Lambda DNA

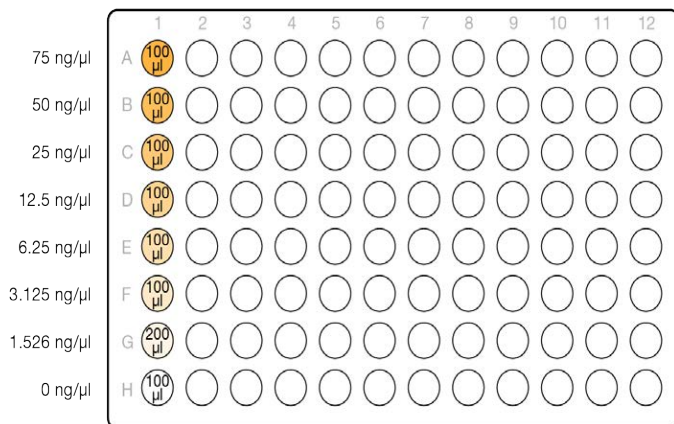

7 Cover the Standard DNA plate with a cap mat.

Dilute PicoGreen

In this step, PicoGreen is diluted for use in the subsequent *Create Standard QDNA Plate* and *Create Sample QDNA Plate* procedures.

1 Prepare a 1:200 dilution of PicoGreen to 1X TE using a sealable 100 ml or 250 ml Nalgene bottle wrapped in aluminum foil.

Use the following table to determine the volumes needed for 96-well QDNA plates.

Number of QDNA Plates	PicoGreen (µl)	1X TE (ml)
1	115	23
2	215	43
3	315	63

2 Cap the foil-wrapped bottle and vortex to mix.

Create Standard QDNA and Sample QDNA Plates

This step transfers the PicoGreen/1X TE dilution to Standard QDNA and Sample QDNA plates, and adds DNA from the respective DNA plates.

CAUTION

Do not run any other programs or applications while using the Tecan robot. Running multiple programs can cause the computer and the robot to lock up and stop a run.

- 1 At the robot PC, select **DNA Quant | Make Quant**.
- 2 Select the DNA plate type.
- 3 In the Basic Run Parameters pane, enter the **Number of DNA/QDNA plates** (1, 2, or 3 pairs) and the **Number of DNA Samples**.
- 4 Vortex DNA Sample plate at 1450 rpm for 1 minute.
- 5 Centrifuge at 280 × g for 1 minute.
- 6 Vortex the Standard QDNA plate at 1450 rpm for 1 minute.

- 7 Centrifuge at 280 × g for 1 minute.
- 8 Place the plates on robot bed according to the robot bed map. Remove plate seals.
- 9 Transfer PicoGreen/1X TE dilution to half reservoir A and place it on the robot bed.
- 10 Clear the **Use Barcodes** checkbox.
- 11 Select **Run**.
- 12 When the process completes, select **OK**.
- 13 When the robot finishes, immediately seal all plates.
- 14 Store DNA and Standard DNA plates at 2° to 8°C or -25°C to -15°C.
- 15 Centrifuge Sample QDNA plate and Standard QDNA plate to 280 × g for 1 minute.

Read QDNA Plate

This step compares the Sample QDNA plate data to the standard curve to obtain the concentration of sample DNA. For best performance, use a minimum concentration of 50 ng/μl.

- 1 Turn on the spectrofluorometer.
- 2 Start the Illumina Fluorometry Analysis program.
- 3 Select **Reader Tasks | Read Quant**.
- 4 Select **Read**.
- 5 When prompted to read a new Standard plate, select **Yes**.
- 6 Remove plate seal and load Standard QDNA plate into the fluorometry tray. Select **OK**.
- 7 Review generated data. Either accept it and continue to the next step, or reject it. Rejecting the data stops the Read Quant process.
- 8 Remove Standard QDNA plate from the spectrofluorometer tray.
- 9 When prompted, enter the number of plates you want to read (1, 2, or 3). Do not include the Standard QDNA plate in this number. Select **OK**.
- 10 When prompted, hand-scan Sample QDNA plate barcode. Select **OK**.
- 11 When prompted, remove plate seal from Sample QDNA plate and load plate into the spectrofluorometer tray, with well A1 at the upper left corner. Select **OK**.
- 12 When the spectrofluorometer is finished reading the data, remove plate from tray.
- 13 When prompted, select **Yes** to review raw Sample QDNA plate data.
- 14 Microsoft Excel shows the quantification data for the Sample QDNA plate. There are 3 tabs in the file:
 - ▶ **SQDNA_STD**—Generates the standard curve by plotting Relative Fluorescence (RF) values measured in the Standard QDNA plate against assumed concentrations in the Standard DNA plate.
 - ▶ **QDNA**—Plots the concentration (ng/μl) of each well of the Sample QDNA plate as derived from the standard curve.
 - ▶ **Data**—Raw data values for Standard QDNA plate and Sample QDNA plate.
- 15 The Illumina Fluorometry Analysis software prompts you to indicate whether you wish to save the QDNA data shown in an Excel file. Select an option:
 - ▶ Select **Yes** to save.

[LIMS] The data is sent to Illumina LIMS where the QDNA plate moves into the *Make Single-Use DNA (SUD) Plate (Pre-PCR)* queue.

- ▶ Select **No** to delete the data. You can read the same plate repeatedly.

16 If you selected to read more than one Sample QDNA plate, repeat the above steps for each additional plate.

SAFE STOPPING POINT

If you are stopping, store the plate(s) at 2°C to 8°C for up to 30 days.

Amplify DNA

This step adds the DNA samples to the plates. The samples are denatured and neutralized to prepare them for amplification.

Consumables

- ▶ MA1
- ▶ RPM
- ▶ MSM
- ▶ 0.1N NaOH
- ▶ 96-well 0.8 ml microplate (midi)
- ▶ DNA plate with 48 or 96 DNA samples (50 ng/μl)
- ▶ Cap mats

Preparation

- 1 Preheat the Illumina Hybridization Oven in the post-amp area to 37°C and allow the temperature to equilibrate.
- 2 Prepare the following consumables:

Item	Storage	Instructions
DNA	-25°C to -15°C	Thaw at room temperature.
MA1	Room temperature	Thaw at room temperature. Invert 10 times to mix, and then pulse centrifuge to eliminate bubbles and collect reagent at the bottom of the tube.
RPM	-25°C to -15°C	Thaw at room temperature. Invert 10 times to mix, and then pulse centrifuge to eliminate bubbles and collect reagent at the bottom of the tube.
MSM	-25°C to -15°C	Thaw at room temperature. Invert 10 times to mix, and then pulse centrifuge to eliminate bubbles and collect reagent at the bottom of the tube.

- 3 Apply an MSA6 barcode label to a new midi plate.

Procedure

- 1 If you do not already have a DNA plate, add DNA into either of the following:
 - ▶ Midi plate: 20 μl to each DNA well
 - ▶ TCY plate: 10 μl to each DNA well
 Apply a barcode label to the new DNA plate.
- 2 At the robot PC, select **MSA6 Tasks | Make MSA6**.

- 3 Select the DNA plate type (MIDI or TCY). Do not mix plate types on the robot.
- 4 In the Basic Run Parameters pane, enter the **Number of DNA plates**.
The robot PC updates the Required Run Items and the bed map to show the correct position of items on the robot bed.



NOTE

If you are using LIMS, you cannot change the number of DNA samples on this screen. The Illumina LIMS software processes the correct number of samples.



NOTE

If you are using LIMS, you must select **Run** and select batches before the robot bed map displays the correct layout for the DNA plates.

- 5 Remove caps from the MA1, RPM, and MSM tubes, then place the tubes in the robot tube rack according to the bed map.
- 6 Pour 15 ml NaOH into a trough. Place trough on robot bed according to bed map.
- 7 Place DNA and MSA6 plates on robot bed according to bed map.

Figure 10 Robot Setup for Make MSA6

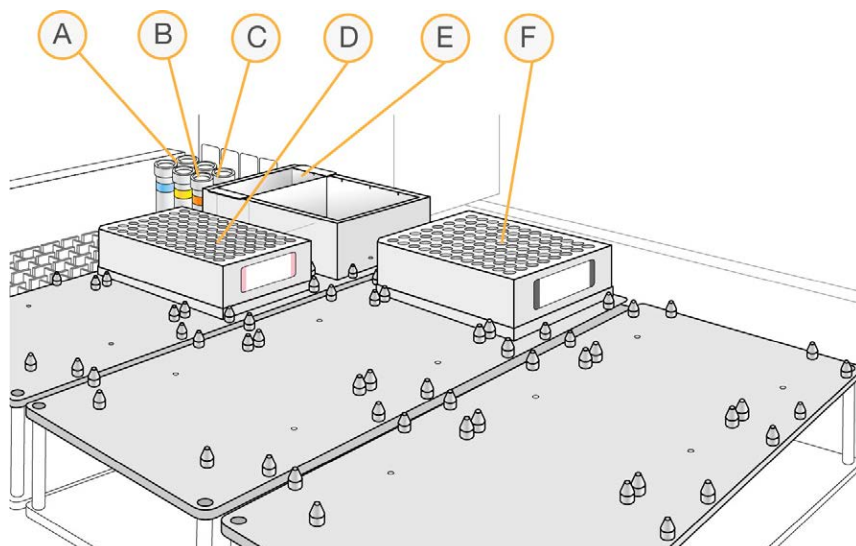

- A MA1 Tube
- B RPM Tube
- C MSM Tube
- D MSA6 Plate
- E NaOH Trough
- F DNA Plate (MIDI)

- 8 At the robot PC, select **Run**.
- 9 When prompted, enter the barcode of each DNA plate.
The robot bed map is updated with the DNA plate locations.
- 10 Place the DNA plates on the robot bed according to the bed map and select **OK**. The robot begins when the plates are in place.

- 11 When the robot has completed the run, vortex the sealed MSA6 plate at 1600 rpm for 1 minute.
- 12 Centrifuge at 280 × g.
- 13 Remove the cap mat, place the MSA6 plate back on the robot bed, and select **OK**.
- 14 When the process is complete, select **OK**.
- 15 Remove and seal the MSA6 plate with a cap mat.
- 16 Centrifuge at 280 × g.



NOTE

Perform the remaining protocol steps in the post-amplification area.

Incubate DNA

This step uniformly amplifies the genomic DNA, generating a sufficient quantity of each individual DNA sample to be used in the Infinium LCG Assay.



NOTE

This and all remaining steps in the workflow are performed in the post-amp lab.

- 1 **[LIMS]** In the Illumina LIMS left pane select **Infinium LCG**
 - a Scan barcode of MSA6 plate.
 - b Select **Verify**, and then select **Save**.
- 2 Incubate the MSA6 plate in the Illumina Hybridization Oven for 20–24 hours at 37°C.

Fragment DNA

This step enzymatically fragments the DNA. An endpoint fragmentation is used to prevent overfragmentation.

Consumables

- ▶ FMS
- ▶ Cap mats

Preparation

- 1 Prepare the following consumable:

Item	Storage	Instructions
FMS	-25°C to -15°C	Thaw at room temperature and invert to mix. Pulse centrifuge at 280 × g for 1 minute.

- 2 Preheat the heat block with the midi plate insert to 37°C.
- 3 If resuspending the MSA6 plate today, remove the RA1 from the freezer and thaw at room temperature.

Procedure

- 1 Pulse centrifuge the MSA6 plate at 280 × g.
- 2 At the robot PC, select **MSA6 Tasks | Fragment MSA6**.
- 3 Place the MSA6 plate on the robot bed according to the bed map. Remove the cap mat.

Figure 11 Robot Setup for Fragment MSA6

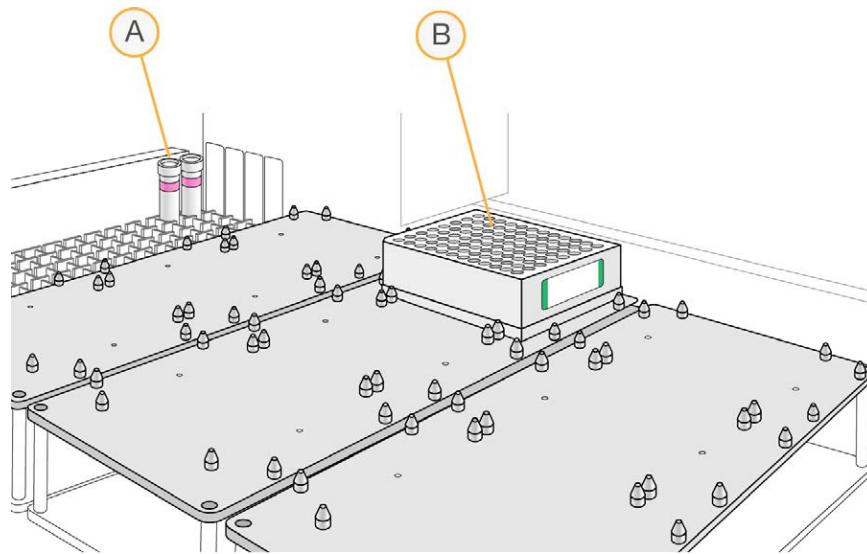

- A FMS
- B MSA6 Plate

- 4 Place FMS tubes in the robot tube rack according to the bed map. Remove the cap mat.
- 5 At the robot PC, select **Run**.
- 6 When the process completes, select **OK**.
- 7 Remove the plate from the robot bed and seal with a cap mat.
- 8 Vortex at 1600 rpm for 1 minute.
- 9 Pulse centrifuge at 280 × g.
- 10 Place the sealed plate on the 37°C heat block for 1 hour.
If you are continuing, leave the plate in the 37°C heat block until you have completed preparation for the next step. Do not leave the plate on the heat block for longer than 2 hours.

SAFE STOPPING POINT

If you are stopping, seal the plate(s), and store at -25°C to -15°C.

Precipitate DNA

This step uses 100% 2-propanol and PM1 to precipitate the DNA.

Consumables

- ▶ 100% 2-propanol
- ▶ PM1
- ▶ Cap mats

Preparation

- 1 Do one of the following:

- ▶ If proceeding immediately from *Fragment DNA*, leave the MSA6 plate on the heat block until preparation is complete.
- ▶ If the MSA6 plate was stored at -25°C to -15°C, thaw at room temperature, pulse centrifuge at 280 × g, and preheat the heat block to 37°C.

2 Prepare the following consumables:

Item	Storage	Instructions
PM1	2°C to 8°C	Thaw at room temperature and invert to mix. Centrifuge at 280 × g for 1 minute.

3 Remove the cap mat.

Procedure

- 1 At the robot PC, select **MSA6 Tasks | Precip MSA6**.
- 2 Pulse centrifuge the sealed plate at 280 × g.
- 3 Remove the cap mat and place the MSA6 plate on the robot bed according to the bed map.
- 4 Place a half reservoir in the reservoir frame according to the robot bed map, and add PM1 as follows:
 - ▶ For 48 samples, add 1 tube PM1
 - ▶ For 96 samples, add 2 tubes PM1
- 5 Place a full reservoir in the reservoir frame according to the robot bed map, and add 2-propanol as follows:
 - ▶ For 48 samples, add 20 ml 2-propanol
 - ▶ For 96 samples, add 40 ml 2-propanol

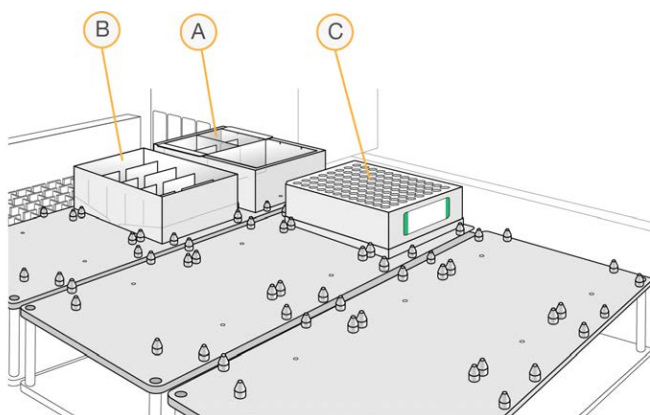

- A PM1 in Half Reservoir
- B 2-Propanol in Full Reservoir
- C MSA6 Plate

- 6 At the robot PC, select **Run**.
- 7 When prompted, remove the MSA6 plate from the robot bed. Do not select **OK**.
- 8 Reseal the MSA6 plate with the cap mat.
- 9 Vortex at 1600 rpm for 1 minute.
- 10 Incubate on the preheated heat block for 5 minutes.
- 11 Centrifuge at 280 × g for 1 minute.

- 12 Set the centrifuge at 4°C to prepare for the next centrifuge step.
- 13 Remove and discard the cap mat.
- 14 Place the MSA6 plate back on the robot bed according to the bed map.
- 15 When prompted, select **OK**.
- 16 Remove the MSA6 plate from the robot bed and carefully seal with a **new, dry** cap mat. Avoid shaking the plate until the cap mat is seated.
- 17 Invert 10 times to mix.
- 18 Incubate at 4°C for 30 minutes.
- 19 Place in the centrifuge opposite another plate of equal weight.
- 20 Centrifuge at 3000 × g for 20 minutes.
 - ▶ When centrifuging is complete, proceed **immediately** to the next step to avoid dislodging the blue pellet.
 - ▶ If a delay occurs, repeat the 20 minute centrifuge.
- 21 Remove MSA6 plate from centrifuge.
- 22 Make sure that a blue pellet is present in the bottom of each sample well.
- 23 Remove and discard the cap mat.
- 24 Hold the plate over an absorbent pad and do as follows.
 - a Quickly invert to decant the supernatant.
 - b Drain liquid onto the absorbent pad, and then smack the plate down. Avoid the liquid drained onto the pad.
- 25 Keeping the plate inverted, firmly tap until all wells are free of liquid (~1 minute). Do not allow supernatant to pour into other wells.
- 26 Place the uncovered, inverted plate on a tube rack for 1 hour at room temperature to air-dry the pellet.
- 27 Make sure that a blue pellet is still present in the bottom of each sample well.

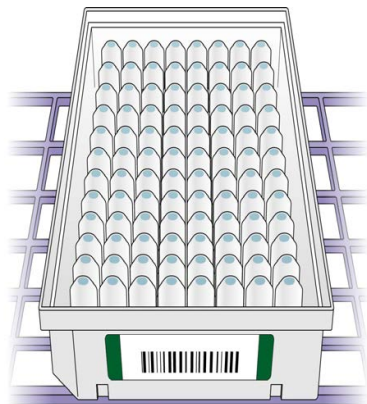

SAFE STOPPING POINT

If you are stopping, seal the plate(s), and store at -25°C to -15°C.

Resuspend DNA

This step uses RA1 to resuspend the precipitated DNA.



WARNING

This set of reagents contains potentially hazardous chemicals. Personal injury can occur through inhalation, ingestion, skin contact, and eye contact. Wear protective equipment, including eye protection, gloves, and laboratory coat appropriate for risk of exposure. Handle used reagents as chemical waste and discard in accordance with applicable regional, national, and local laws and regulations. For additional environmental, health, and safety information, see the SDS at support.illumina.com/sds.html.

Consumables

- ▶ RA1
- ▶ Foil heat seals

Preparation

- 1 If the MSA6 plate was stored at -25°C to -15°C, thaw at room temperature, and then remove the cap mats.
- 2 Prepare the following consumable:

Item	Storage	Instructions
RA1	-25°C to -15°C	Thaw at room temperature and invert to mix.

- 3 Preheat the Illumina Hybridization Oven to 48°C.
- 4 Preheat the heat sealer for at least 20 minutes before use.

Procedure

- 1 At the robot PC, select **MSA6 Tasks | Resuspend MSA6**.
- 2 Place the MSA6 plate on the robot bed according to the bed map.

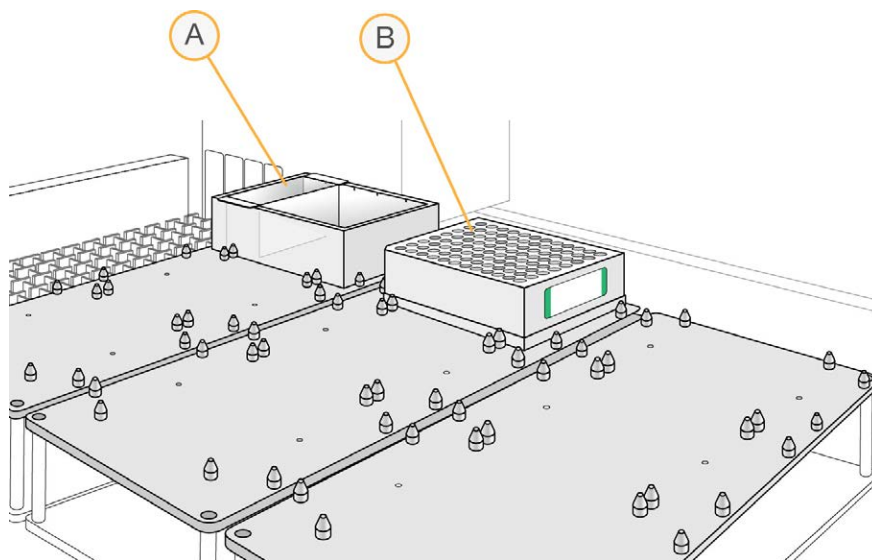

- A RA1 in Quarter Reservoir
- B MSA6 Plate

- 3 Place a quarter reservoir in the reservoir frame according to the robot bed map, and add RA1 as follows:
 - ▶ For 48 samples, add 4.5 ml RA1
 - ▶ For 96 samples, add 9 ml RA1
- 4 At the robot PC, select **Run**.
- 5 Remove the MSA6 plate from the robot deck.
- 6 Apply a foil seal to the MSA6 plate using the heat sealer.
- 7 Incubate in the preheated Illumina Hybridization Oven for 1 hour.
- 8 Vortex the plate at 1800 rpm for 1 minute.
- 9 Check to make sure that the pellets are resuspended. If necessary, repeat the incubation and vortexing steps.
- 10 Pulse centrifuge at $280 \times g$.

SAFE STOPPING POINT

If you are stopping, store sealed MSA6 plate(s) at 2°C to 8°C for up to 24 hours. If more than 24 hours, store at -25°C to -15°C.

Store sealed RA1 at -25°C to -15°C. If RA1 will be used the next day, seal it, and store it overnight at 4°C.

Hybridize DNA to the BeadChip

This step dispenses the fragmented, resuspended DNA onto BeadChips. Incubation then hybridizes each DNA sample to a section of the BeadChip.

Consumables

- ▶ 1% aqueous Alconox solution
- ▶ 100% EtOH
- ▶ DI H₂O
- ▶ PB2
- ▶ XC4

Preparation

- 1 If frozen, thaw the MSA6 plate at room temperature, and then centrifuge at $280 \times g$ for 1 minute.
- 2 Remove BeadChips from storage, but do not unpackage.
- 3 Preheat the heat block to 95°C.
- 4 Preheat the Illumina Hybridization Oven to 48°C.

Prepare Robot Tip Alignment Guide

- 1 Make sure you have the correct robot tip alignment guide for the assay. The barcode says **Guide-F**.

Figure 12 Guide-F Robot Tip Alignment Guide

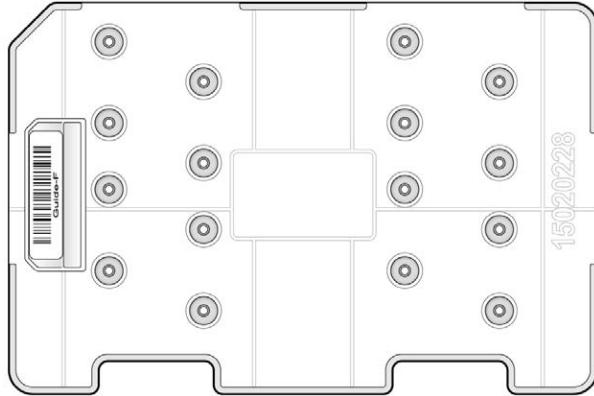

- 2 Wash and dry the robot tip alignment guide. For washing instructions, see *Wash Robot Tip Alignment Guide* on page 59.

Procedure

Denature DNA

- 1 Place the MSA6 plate on the preheated heat block for 20 minutes to denature the DNA.
- 2 Cool the MSA6 plate on the benchtop at room temperature for 30 minutes.
- 3 Pulse centrifuge at $280 \times g$.

Assemble Hybridization Chambers

Assemble one chamber for every four BeadChips by following the steps in this section.

Figure 13 BeadChip Hybridization Chamber Components

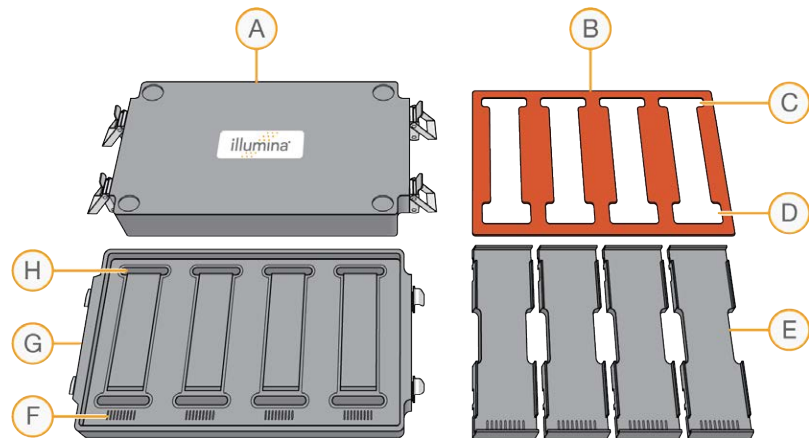

- A Top of BeadChip Hybridization Chamber
- B Hybridization Chamber Gasket
- C Narrower Edges
- D Wider Edges
- E Hybridization Chamber Inserts
- F Barcode Ridges
- G Bottom of BeadChip Hybridization Chamber
- H Humidifying Buffer Reservoirs

- 1 Place the gasket into the hybridization chamber.
 - ▶ Match the wider edge of the hybridization chamber gasket to the barcode-ridge side of the hybridization chamber.
 - ▶ Press down on the edges of the gasket to make sure it is properly seated.



- 2 Add 400 μ l PB2 into each of the eight humidifying buffer reservoirs in the hybridization chamber.
- 3 Place the hybridization chamber insert into the hybridization chamber. Position the barcode ridges on the hybridization chamber insert over the barcode ridges on the hybridization chamber.

- 4 Immediately cover the chamber with the lid to prevent evaporation.
- 5 Leave the closed chambers on the benchtop at room temperature until the BeadChips are loaded with DNA (~1 hour).
- 6 **[LIMS]** Select **Infinium LCG | Confirm for Hyb.**
 - a Scan the barcode of each MSA6 plate you plan to hybridize.
 - b Scan the BeadChip barcode on the package of each BeadChip you plan to hybridize.
 - c Select **Verify**.

Prepare the Robot

- 1 Remove all BeadChips from packaging.
- 2 Place BeadChips into the robot BeadChip alignment fixtures. Align the barcode end with the ridges stamped into the robot BeadChip alignment fixture.

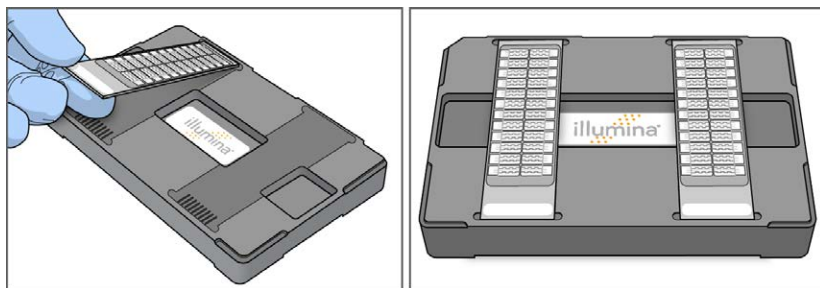

- 3 Stack the robot BeadChip alignment fixtures and carry them to the robot.
- 4 At the robot PC, select **MSA6 Tasks Tasks | Hyb.**
 - a In the BeadChip Selection dialog box, select the 24-sample BeadChip.
 - b In the Basic Run Parameters pane, enter the value for the **Number of MSA6 plates**.
- 5 Place the robot BeadChip alignment fixtures onto the robot deck according to the deck map in [Figure 14](#).
- 6 Pulse centrifuge the MSA6 plate at 280 × g.
- 7 Place the MSA6 plate onto the robot deck according to the deck map, and remove the heat seal.

Figure 14 Robot Deck Setup for Hybridization*

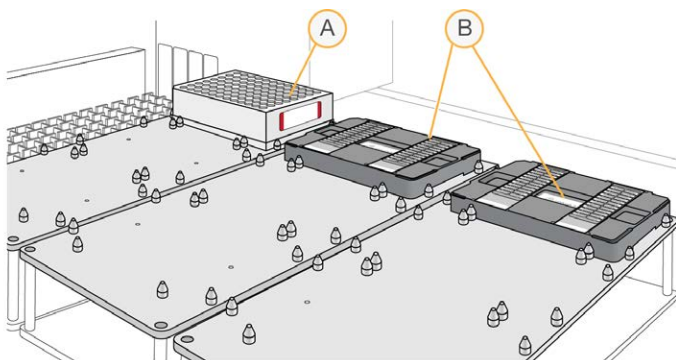

- A MSA6 Plate
- B Robot BeadChip Alignment Fixtures



CAUTION

BeadChips must be transferred to hybridization chambers immediately at the end of the next procedure (*Start the Robot*). Do not begin *Start the Robot* if you cannot immediately transfer the BeadChips.

Start the Robot

- 1 At the robot PC, select **Run**.
 - ▶ The robot scans the barcode on the BeadChips to confirm the correct BeadChips are loaded.
- 2 Place each robot tip alignment guide on top of each robot BeadChip alignment fixture.
- 3 At the robot PC, select **OK**.
 - ▶ The robot scans the barcode on the robot tip alignment guide to confirm that the correct tip guide is being used.
 - ▶ The robot dispenses DNA sample to the BeadChips.
 - ▶ When the process is complete, the robot PC sounds an alert and opens a message box.
- 4 When the robot finishes, at the robot PC, select **OK**.
- 5 Remove the robot BeadChip alignment fixtures from the robot deck.



CAUTION

BeadChips must be removed from the robot deck immediately to prevent excess sample evaporation. Proceed to the next section (*Set Up and Incubate BeadChips*) immediately.

Set Up and Incubate BeadChips

- 1 Make sure that the Illumina Hybridization Oven is set to 48°C.



WARNING

Keep hybridization chambers at room temperature when you load the BeadChips. Do not place the hybridization chamber in the Illumina Hybridization Oven when loading the BeadChips.

- 2 Open each hybridization chamber, and then carefully place each BeadChip in a hybridization chamber insert
Orient the barcode end so that it matches the barcode symbol on the insert.

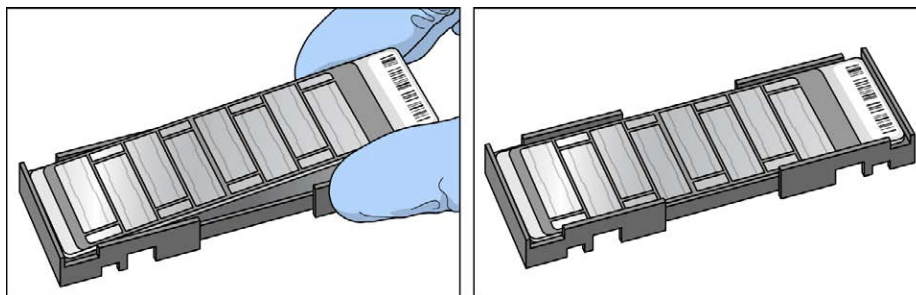

- 3 Make sure that hybridization chamber inserts are seated properly in the hybridization chambers.
- 4 Apply the back side of the hybridization chamber lid first, and then slowly bring down the front end to avoid dislodging the hybridization chamber inserts.

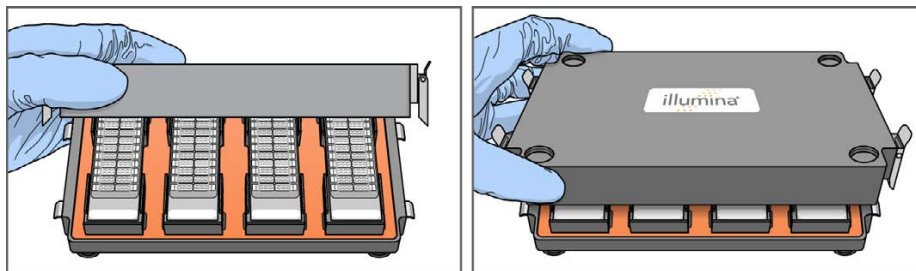

- 5 Close the hybridization chamber clamps in this order: top-left, bottom-right, top-right, and then bottom-left. Make sure that the lid is secure and even on the base (no gaps).



CAUTION

Keep the hybridization chamber steady and level when moving it or transferring it to the Illumina Hybridization Oven.

- 6 **[LIMS]** Select **Infinium LCG | Prepare Hyb Chamber**.

- a Scan the barcode of the PB2 bottles.
- b Scan the BeadChip barcode on each BeadChip package.
- c Select **Verify**, and then select **Save**.

- 7 Place the hybridization chamber in the preheated Illumina Hybridization Oven with the clamps of the hybridization chamber facing the front and back of the oven.

If you are stacking multiple hybridization chambers in the Illumina Hybridization Oven, fit the feet of each hybridization chamber into the matching indents on the lid of the hybridization chamber below it. You can stack up to 3 hybridization chambers in two rows, for a maximum of 6 total hybridization chambers in the Illumina Hybridization Oven.

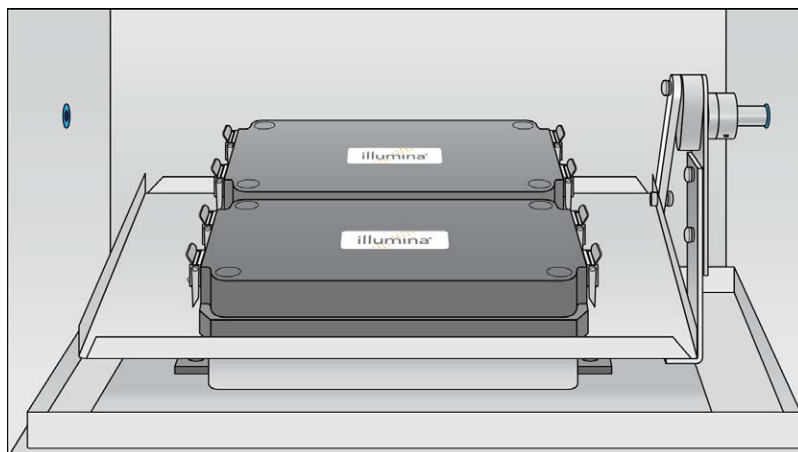

OVERNIGHT INCUBATION

Incubate at 48°C for 16–24 hours.

Resuspend XC4 Reagent

Resuspend XC4 to prepare for the *Extend and Stain BeadChips* step.

- 1 Add 330 ml fresh 100% EtOH to the XC4 bottle.
The resulting volume is ~ 350 ml. Each XC4 bottle can process up to 24 BeadChips.

- 2 Vigorously shake to resuspend.
- 3 Leave the bottle upright on the lab bench overnight.



NOTE

If XC4 was not left to resuspend overnight, you can still proceed with the assay.

Wash Robot Tip Alignment Guide

For optimal performance, wash and dry the robot tip alignment guides after each use.

- 1 Soak the robot tip alignment guides in 1% aqueous Alconox solution (1 part Alconox to 99 parts water) for 5 minutes. Do not use bleach or ethanol to clean HTS tip guide inserts.
- 2 Thoroughly rinse the robot tip alignment guides with DI H₂O at least 3 times to remove any residual detergent.
- 3 Dry the robot tip alignment guides. Make sure that the robot tip alignment guides are free of any residual contaminants before next use.

Wash BeadChips

This step prepares the BeadChips for the staining process.

Consumables

- ▶ 95% Formamide/1 mM EDTA
- ▶ ATM
- ▶ EML
- ▶ PB1
- ▶ ATM
- ▶ SML
- ▶ LX1
- ▶ LX2
- ▶ XC3
- ▶ XC4

About Reagents

- ▶ Decant only the reagent volume needed for each step. Some reagents are needed later in the protocol.
- ▶ Excepting PB1, all reagents are prepared in this step for use in a subsequent step.



WARNING

This set of reagents contains potentially hazardous chemicals. Personal injury can occur through inhalation, ingestion, skin contact, and eye contact. Wear protective equipment, including eye protection, gloves, and laboratory coat appropriate for risk of exposure. Handle used reagents as chemical waste and discard in accordance with applicable regional, national, and local laws and regulations. For additional environmental, health, and safety information, see the SDS at support.illumina.com/sds.html.

Preparation

- 1 Remove each hybridization chamber from the hybridization oven. Allow to cool for 30 minutes before opening.
- 2 Prepare the following items:
 - ▶ Fill two wash dishes with 200 ml PB1 each and label them Wash 1 and Wash 2.
 - ▶ Using a graduated cylinder, fill the Multi-Sample BeadChip Alignment Fixture with 150 ml PB1.
- 3 Remove the following Te-Flow flow-through chamber components from storage:
 - ▶ Black frames
 - ▶ Spacers (separated for ease of handling)
 - ▶ Clean glass back plates
 - ▶ Clamps
- 4 Prepare the following consumables for the subsequent *Extend and Stain BeadChips* step:

Item	Storage	Instructions
95% Formamide/1mM EDTA	-25°C to -15°C	Thaw at room temperature. Invert 10 times to mix.
ATM	-25°C to -15°C	Thaw at room temperature. Invert 10 times to mix.
EML	-25°C to -15°C	Thaw at room temperature. Invert 10 times to mix.
PB1	Room temperature	Thaw at room temperature. Invert 10 times to mix.
RA1	-25°C to -15°C	Shake vigorously to resuspend. If necessary, vortex until dissolved.
SML	-25°C to -15°C	Thaw at room temperature. Invert 10 times to mix.
LX1	-25°C to -15°C	Thaw at room temperature. Invert 10 times to mix.
LX2	-25°C to -15°C	Thaw at room temperature. Invert 10 times to mix.
XC3	Room temperature	Thaw at room temperature. Invert 10 times to mix.
XC4	Room temperature	Thaw at room temperature. Invert 10 times to mix.

Procedure

Wash BeadChips

- 1 Attach the wire handle and submerge the wash rack in Wash 1 containing 200 ml PB1.



CAUTION

Replace PB1 in Wash 1 after every 12 BeadChips.



- 2 Remove the hybridization insert from the hybridization chambers.
- 3 Remove the BeadChips from the hybridization insert.
- 4 Remove the cover seals from the BeadChips.
Using powder-free gloved hands, hold the BeadChip securely and by the edges in one hand. Remove the entire seal in a single, continuous motion. Do not touch exposed arrays.

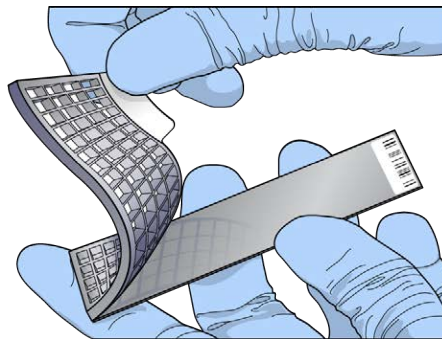
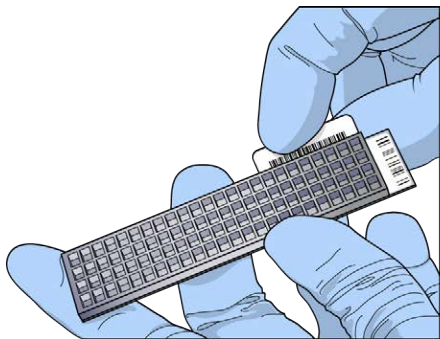

- 5 Immediately and carefully slide each BeadChip into the wash rack in Wash 1. Make sure that the BeadChip is submerged in PB1.
- 6 Repeat steps 4–5 until all BeadChips are transferred to the submerged wash rack in Wash 1.
- 7 Move the wash rack up and down for 1 minute. Break the surface of the PB1 with gentle, slow agitation.
- 8 Move the wash rack to Wash 2 containing clean PB1. Make sure that the BeadChips are submerged.
- 9 Move the wash rack up and down for 1 minute. Break the surface of the PB1 with gentle, slow agitation.
- 10 Remove the BeadChips from the wash rack and inspect them for remaining residue.
If you see residue, submerge the BeadChip in PB1 and carefully use a pipette tip to remove the remaining residue.

Assemble Flow-Through Chambers

- 1 Confirm that you are using the correct Infinium LCG glass back plates and spacers before proceeding.

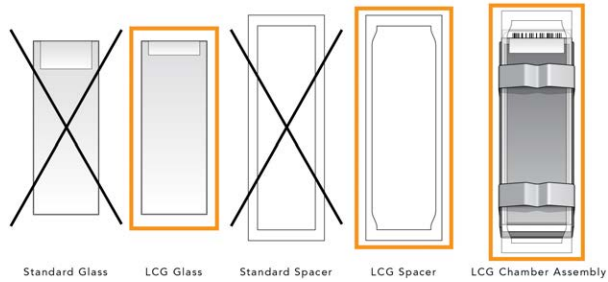

- 2 Fill the BeadChip alignment fixture with 150 ml PB1.
- 3 For each BeadChip, place one black frame into the BeadChip alignment fixture.
For example, if you are processing four BeadChips, place four black frames into the fixture.



- 4 Place each BeadChip into a black frame, aligning the barcode with the alignment fixture ridges. Fully submerge each BeadChip.



- 5 Place a **clear** spacer onto the top of each BeadChip. Use the alignment fixture grooves to guide the spacers into position.
The white spacers are not a substitute for the clear spacers.



- 6 Place the alignment bar onto the alignment fixture. Fit the groove on the alignment bar over the tab on the alignment fixture.

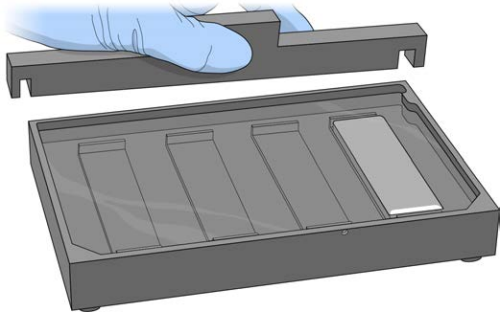

- 7 Place a clean glass back plate on top of each clear spacer. Position the plate reservoir at the barcode end of the BeadChip, facing inward to create a reservoir against the BeadChip surface.

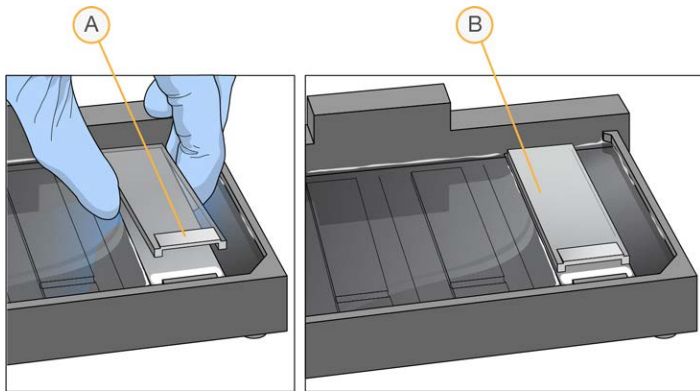

- A Reservoir at the barcode end of the glass back plate.
- B Glass back plate in position.

- 8 Secure each flow-through chamber assembly with metal clamps as follows.
 - a Using one finger, gently push the glass back plate against the alignment bar.
 - b Place a metal clamp around the flow-through chamber 5 mm from the top edge.
 - c Place a second metal clamp around the flow-through chamber at the barcode end, 5 mm from the bottom of the reagent reservoir.

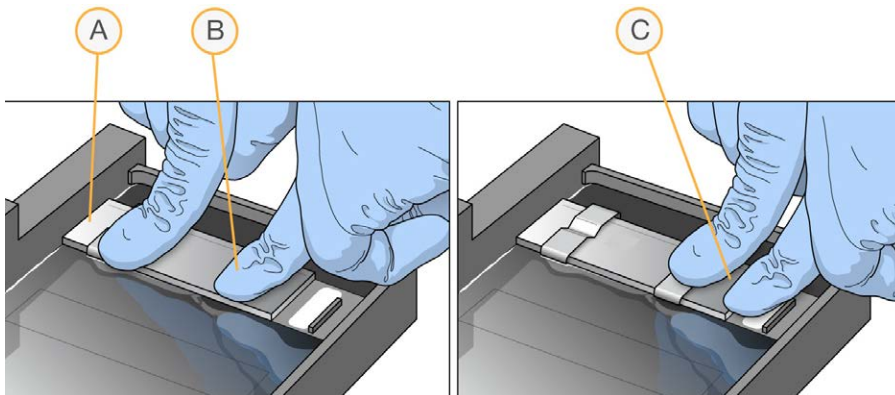

- A One stripe is visible between the first clamp and the alignment bar.
- B Glass back plate pressed against the alignment bar.
- C Stripes are not visible between the second clamp and the barcode.

- 9 Remove the assembled flow-through chamber from the alignment fixture.
- 10 Starting at the nonbarcode end, trim the spacers from each end of the assembly using scissors.

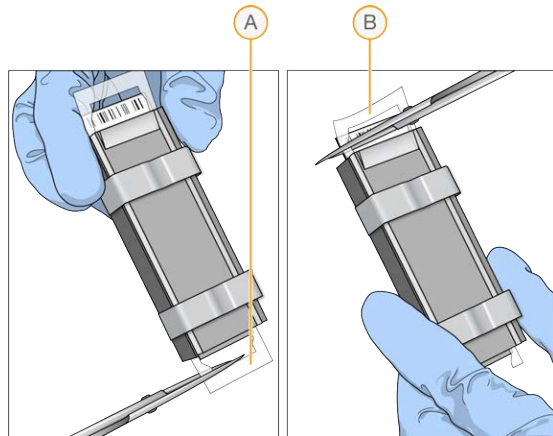

- A Trimming the spacer at the nonbarcode end.
 B Trimming the spacer at the barcode end.

- 11 Leave assembled flow-through chambers on the lab bench in a horizontal position until ready to load onto chamber rack in the *Extend and Stain BeadChips* step.
 - ▶ Do not place on absorbent paper.
 - ▶ Do not place in the chamber rack until instructed to do so.
- 12 Wash the hybridization chamber reservoirs with DI H₂O.
 Immediate and thorough washing ensures complete removal of PB1 from the wells.

Extend and Stain BeadChips

This step washes unhybridized and nonspecifically hybridized DNA samples from the BeadChips, adds labeled nucleotides to extend primers hybridized to the sample, and stains the primers. After the flow-through chambers are disassembled, the BeadChips are coated for protection.

Consumables

- ▶ 70% EtOH (Ethanol)
- ▶ 95% formamide/1 mM EDTA (10 ml for 1–4 BeadChips)
- ▶ Alconox Powder Detergent
- ▶ ATM (1 tube/4 BeadChips)
- ▶ EML (1 tube/4 BeadChips)
- ▶ PB1 (310 ml for 1–8 BeadChips, 285 ml for 9–24 BeadChips)
- ▶ RA1 (10 ml for 1–8 BeadChips, 20 ml for 9–16 BeadChips, 30 ml 17–24 BeadChips)
- ▶ SML (1 tube/4 BeadChips)
- ▶ LX1 (1 tube/4 BeadChips)
- ▶ LX2 (1 tube/4 BeadChips)
- ▶ XC3 (50 ml for 1–8 BeadChips, 100 ml for 9–16 BeadChips, 150 ml for 17–24 BeadChips)
- ▶ XC4 (310 ml for 1–8 BeadChips, 285 ml for 9–24 BeadChips)

About Reagents

- ▶ Make sure that the label of each SML tube indicates the same stain temperature.
- ▶ Decant only the necessary volume of reagent.
- ▶ Use fresh RA1 for each step that requires it. Properly stored RA1 that has not been dispensed for the previous resuspension step or this extend and stain step is considered fresh.
- ▶ RA1 might form visible precipitate or crystals. Before each use, hold in front of a light and inspect. Invert several times to redissolve the solution as needed.
- ▶ The XC4 coat is slippery and makes the BeadChips difficult to hold. Self-locking tweezers grip the BeadChip firmly and help prevent damage.



WARNING

This set of reagents contains potentially hazardous chemicals. Personal injury can occur through inhalation, ingestion, skin contact, and eye contact. Wear protective equipment, including eye protection, gloves, and laboratory coat appropriate for risk of exposure. Handle used reagents as chemical waste and discard in accordance with applicable regional, national, and local laws and regulations. For additional environmental, health, and safety information, see the SDS at support.illumina.com/sds.html.

Preparation

- 1 Prepare the following consumable:

Item	Storage	Instructions
RA1	-25°C to -15°C	Thaw at room temperature.

- 2 Place reagent tubes in a rack in the order of use: LX1, LX2, EML, 95% Formamide / 1mM EDTA, SML, ATM.

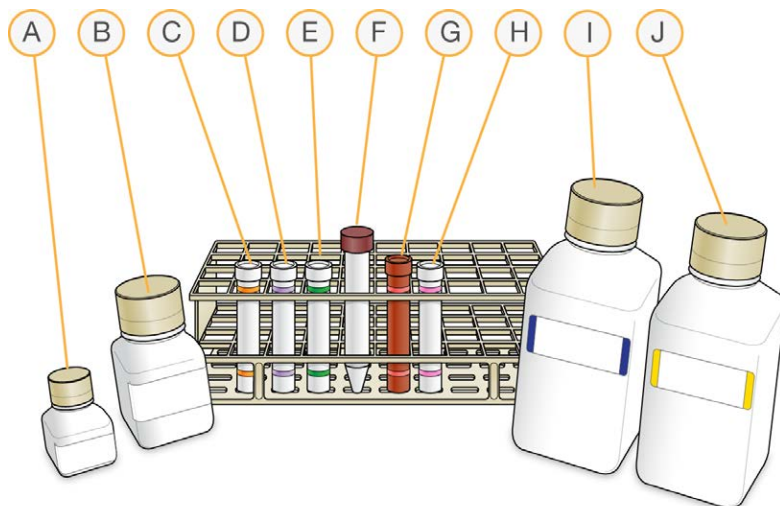

- A RA1
- B XC3
- C LX1
- D LX2
- E EML

- F 95% Formamide / 1mM EDTA
- G SML
- H ATM
- I PB1
- J XC4

Procedure

Set Up the Chamber Rack

- 1 Make sure that the water circulator is filled to the appropriate level. See the *VWR Operator Manual*, VWR part # 110-229.
- 2 At the robot PC, select **Robot QC Tasks | Circulator Manager** to set the water circulator to 44°C:
 - a In the Action section drop-down list, select **Set Target Temperature**.
 - b In the field below Set Target Temperature, enter **44**.
 - c Select the **Execute** button.

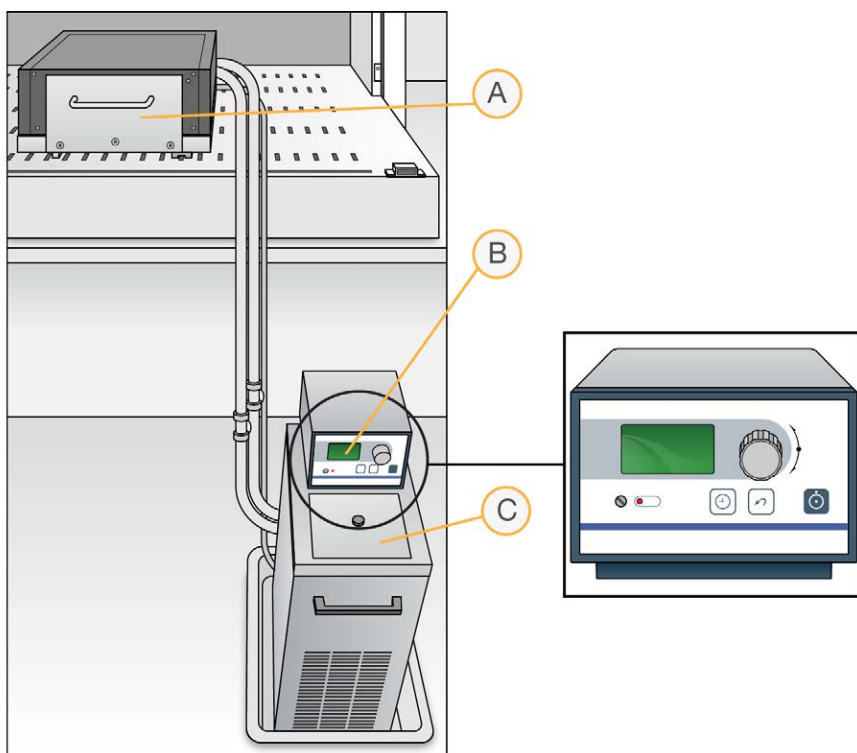

- A Chamber rack
- B Water circulator with programmable temperature controls
- C Reservoir cover

- 3 Remove bubbles trapped in the chamber rack.
 - a Separate the heat exchanger from the reagent pan.
 - b Lift the heat exchanger upright and away from you with the tubing at the bottom, and turn 90° counter clockwise.

- c Return the heat exchanger to a horizontal position.
 - d Repeat steps b and c 3 times for a total of 4 rotations or until all bubbles are removed.
 - e Using Kimwipes dampened with laboratory-grade water, clean all surfaces between the heat exchanger and reagent pan. Discard Kimwipes with formamide waste.
 - f Place the Te-Flow back on the reagent pan. Using the two guide pins in the reagent pan, make sure that the Te-Flow is flush.
- 4 Using the Illumina temperature probe, test at least three locations on the chamber rack.
- a For accurate measurements, make sure that the temperature probe touches the base of the chamber rack.
 - b Make sure that all locations are at 44°C ± 0.5°C.
 - c If the temperature is not within ± 0.5°C, adjust the water circulator control knob to reach 44°C ± 0.5°C.
 - d Do not leave the temperature probe in the first three rows of the chamber rack. Reserve these rows for BeadChips.

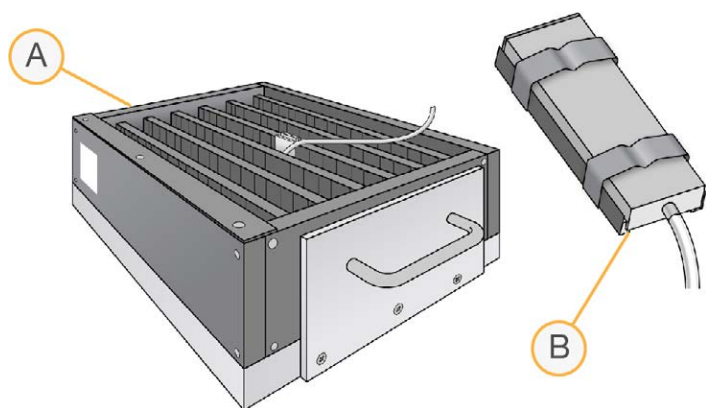

A Chamber rack with temperature probe
 B Temperature probe

Single-Base Extension and Stain

This step uses a robot to process the BeadChips.



CAUTION

The following steps must be performed without interruption.

- 1 At the robot PC, select **XStain Tasks | XStain LCG BeadChip**.
- 2 Place reservoirs on the robot deck according to the deck map, and add reagents to reservoirs as follows:

Reagent	# BeadChips	Volume
95% formamide/1 mM EDTA	1–8	15 ml
	9–16	17 ml
	17–24	25 ml
RA1	1–8	10 ml

Reagent	# BeadChips	Volume
	9–16	20 ml
	17–24	30 ml
XC3	1–8	50 ml
	9–16	100 ml
	17–24	150 ml

3 Invert the LX1, LX2, EML, SML, and ATM tubes to mix. Remove the caps, and place on the robot deck according to the deck map.

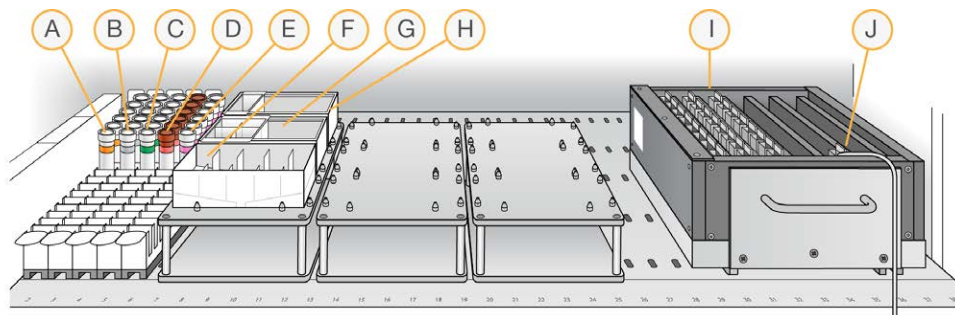

- A LX1 Tubes
- B LX2 Tubes
- C EML Tubes
- D SML Tubes
- E ATM Tubes
- F XC3 in Full Reservoir
- G RA1 in Half Reservoir
- H 95% Formamide/1 mM EDTA in Quarter Reservoir
- I 24 BeadChips in Chamber Rack
- J Temperature Probe

- 4 In the Basic Run Parameters pane, enter the number of BeadChips, up to 24.
- 5 Select **Run**.
- 6 [Non-LIMS] When prompted, enter the stain temperature listed on the SML tube. Do not load the BeadChips yet.
- 7 When the chamber rack reaches 44°C, place the flow-through chambers into the chamber rack, according to the robot deck map.



CAUTION

Start the robot immediately to prevent BeadChips from drying.

- 8 At the robot PC, select **OK**.
- 9 When the robot finishes, remove the flow-through chambers from the chamber rack, and place them horizontally on the lab bench at room temperature.

Wash and Coat BeadChips

- 1 Gather the following equipment:

- ▶ Kimwipes, large
 - ▶ Staining rack
 - ▶ Self-locking tweezers
 - ▶ Tube rack
 - ▶ Vacuum desiccator
 - ▶ Vacuum hose
 - ▶ Wash dishes (2)
- 2 During the procedure, prevent dust or lint from entering the wash dishes.
 - ▶ Clean wash dishes with low-pressure air before use.
 - ▶ Cover wash dishes with wash dish covers when not in use.
 - 3 Wash the tube racks and wash dishes thoroughly after each use.
 - ▶ Rinse with deionized water.
 - ▶ Dry racks and wash dishes upside down on a wash rack.
 - 4 Place a clean tube rack on top of several layers of Kimwipes or an absorbent pad. After the staining rack containing BeadChips is removed from the XC4 wash dish, it is placed on this rack.
 - 5 Prepare another clean tube rack that fits the internal dimensions of vacuum desiccator for removal of the BeadChips. Allow one rack per eight BeadChips. Kimwipes are not needed under this tube rack.
 - 6 Set up two top-loading wash dishes labeled PB1 and XC4.
 - 7 To indicate fill volume of each wash dish:
 - a Add 310 ml water.
 - b Mark the water level on the side.
 - c Empty the water.

Indicating fill volume before adding reagents allows reagents to be added directly from the bottles, minimizing contamination.

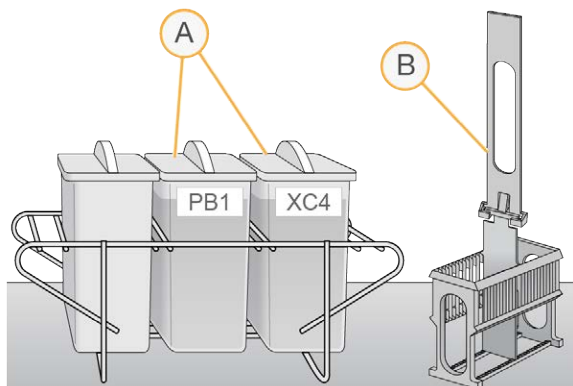

- A Labeled and filled wash dishes
- B Staining rack

- 8 Add 310 ml PB1 to the PB1 wash dish.
- 9 Submerge the staining rack in the wash dish so that the locking arms and tab **face you**. This orientation ensures that you can safely remove the BeadChips.

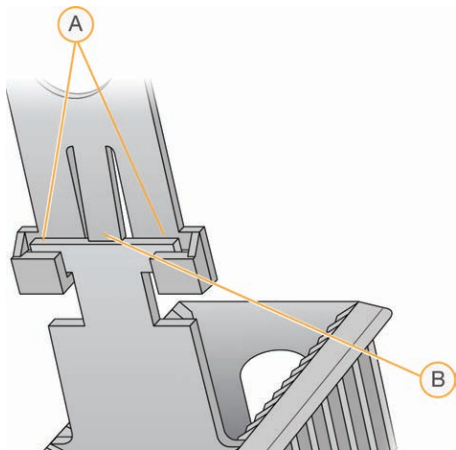

- A Locking arms
- B Tab

- 10 Leave the staining rack in the wash dish for later use (carrying the BeadChips after disassembling the flow-through chambers).
- 11 **Using the dismantling tool**, remove the two metal clamps from a flow-through chamber. The dismantling tool prevents chipping the glass back plates.

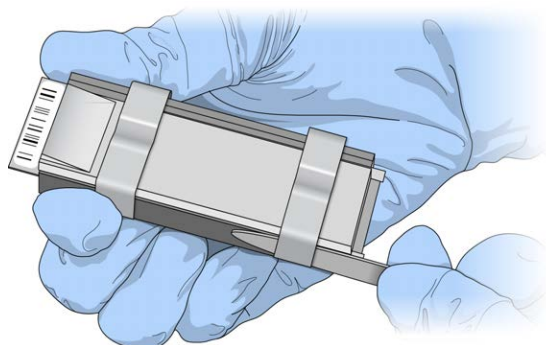

- 12 Lift the glass back plate straight up to remove. Set aside for cleaning after finishing this procedure. Sliding the glass along the BeadChip can damage the BeadChip.
- 13 Pull out the spacer so that the long side slides along the BeadChip sides. This technique prevents damaging the BeadChip stripes.
- 14 Remove the BeadChip from the black frame. Handle the BeadChip only by the barcode end or edges.
- 15 Repeat steps 11–14 to disassemble each flow-through chamber one at a time.
- 16 Place the BeadChips into the submerged staining rack. Make sure that the BeadChip barcodes face **away** from you and the locking arms face **toward** you.



CAUTION

Submerge each BeadChip as quickly as possible to prevent drying.

- 17 If necessary to seat a BeadChip, briefly lift the staining rack from the wash dish and seat the BeadChip.
- 18 Make sure that the BeadChips are submerged.

- 19 Slowly lift the staining rack up and down 10 times, breaking the PB1 surface. If the tops of the BeadChips touch, gently wiggle the staining rack to separate the slides. Free circulation of PB1 between BeadChips is important.

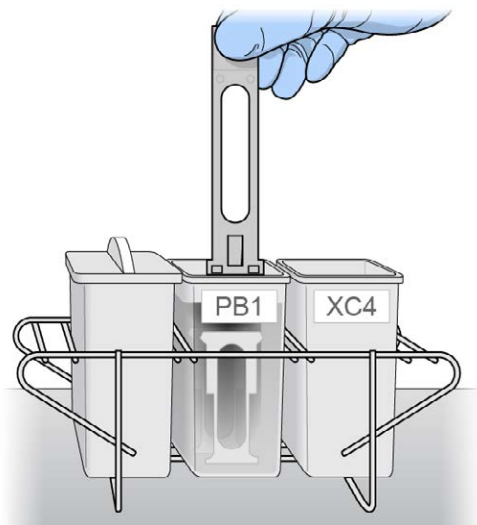

- 20 Soak for 5 minutes.
- 21 Vigorously shake the XC4 bottle to resuspend completely. If necessary, vortex until dissolved.
- 22 Add 310 ml XC4 to the XC4 wash dish.
- ▶ Cover to prevent lint or dust from entering.
 - ▶ Do not let sit for more than 10 minutes.
- 23 Transfer the staining rack from the PB1 wash dish to the XC4 wash dish.

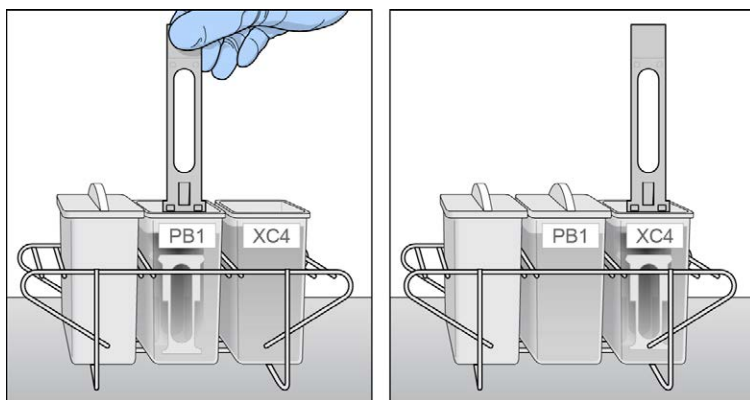

- 24 Slowly lift the staining rack up and down 10 times, breaking the XC4 surface. If the tops of the BeadChips touch, gently wiggle the staining rack to separate the slides.
- 25 Soak for 5 minutes.
- 26 Remove the staining rack in one quick motion and place it onto the prepared tube rack.

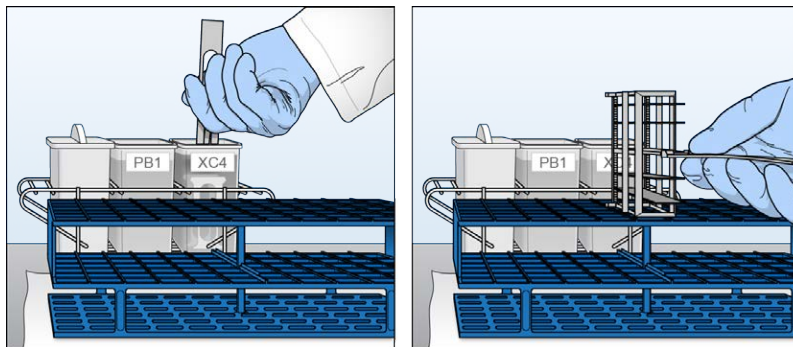

27 Make sure that the staining rack is in the center of the tube rack to ensure uniform coating. Avoid the raised edges.

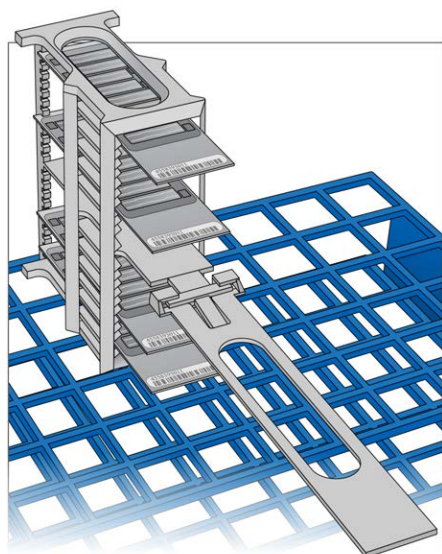

28 **[Optional]** Remove the staining rack handle to facilitate BeadChip removal:

- a Holding the top of the staining rack in position, grasp the handle between your thumb and forefinger.
- b Push up the tab with your thumb and push the handle away from you, unlocking the handle.
- c Pull up the handle and remove.

29 Working top to bottom, dry each BeadChip as follows.

- a Holding the staining rack handle (if present), use self-locking tweezers to grip the BeadChip by the barcode end.
- b Place the BeadChip onto a tube rack with the barcode facing up and toward you. Do not place on the bottom rack or allow BeadChips to rest on the tube rack edge or touch each other.

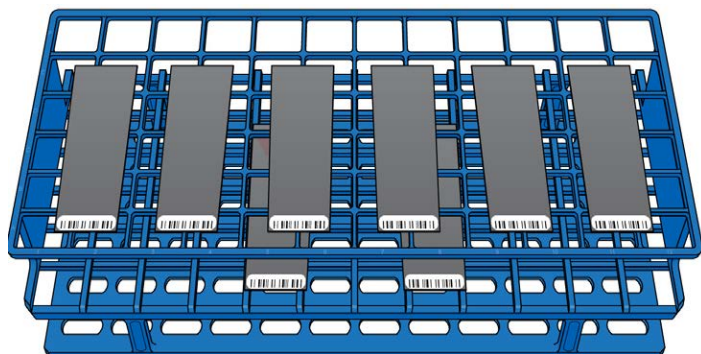

Proper BeadChip placement prevents wicking, uneven drying, and pooled dye protectant.

- 30 Place the tube rack into the vacuum desiccator.
Each desiccator can hold one tube rack (eight BeadChips).
- 31 Make sure that the vacuum valve is seated tightly and securely, and remove the red plug from the three-way valve.
- 32 Gently lift the vacuum desiccator lid to ensure proper sealing. Make sure that the lid does not lift off the desiccator base.
- 33 Dry the BeadChips in the vacuum desiccator for 50–55 minutes at 675 mm Hg (0.9 bar).
Drying times can vary according to room temperature and humidity.
- 34 Release the vacuum by turning the handle slowly.



WARNING

Make sure that air enters the desiccator very slowly to avoid disturbing the contents. Improper use of the vacuum desiccator can result in damage to the BeadChips, especially if you remove the valve plug while a vacuum is applied. For detailed vacuum desiccator instructions, see the documentation included with the desiccator.

- 35 Return the desiccator to storage. Store with the red valve plug in the three-way valve of the desiccator to prevent dust and lint from accumulating in the valve port.
- 36 Touch the BeadChip **borders** (not the stripes) to make sure that the barcode sides of the BeadChips are dry to the touch.
- 37 Clean the back of each BeadChip using a Kimwipe sprayed with 70% EtOH:
 - a Hold the BeadChip at a downward angle to prevent excess EtOH from dripping onto the stripes.
 - b Without touching the stripes, wipe the underside of the BeadChip until XC4 is removed (5–6 times).
- 38 Image the BeadChips immediately, or store them, protected from light.
- 39 [LIMS] When you are ready to image the BeadChips, in Illumina LIMS, select **Infinium LCG | Coat**.
 - a Scan the barcode of the reagent bottles.
 - b Scan each BeadChip barcode.
Scan the BeadChip barcode from either the BeadChip or the BeadChip package.
 - c Select **Verify**, and then select **Save**.

Image BeadChip

Follow the instructions in the System Guide for your instrument to scan your BeadChips.

Use the **Infinium LCG** scan setting for your BeadChip.

Illumina GenomeStudio

The Illumina GenomeStudio Genotyping Module, included with your Illumina Infinium Assay system, is an application for extracting genotyping data from intensity data files (*.idat files) collected from your Illumina scanning instrument.

For feature descriptions and instructions on using the GenomeStudio platform to visualize and analyze genotyping data, see the *GenomeStudio Framework User Guide* and the *GenomeStudio Genotyping User Guide*.

Technical Assistance

For technical assistance, contact Illumina Technical Support.

Website: www.illumina.com
Email: techsupport@illumina.com

Illumina Customer Support Telephone Numbers

Region	Toll Free	Regional
North America	+1.800.809.4566	
Australia	+1.800.775.688	
Austria	+43 800006249	+43 19286540
Belgium	+32 80077160	+32 34002973
China	400.066.5835	
Denmark	+45 80820183	+45 89871156
Finland	+358 800918363	+358 974790110
France	+33 805102193	+33 170770446
Germany	+49 8001014940	+49 8938035677
Hong Kong	800960230	
Ireland	+353 1800936608	+353 016950506
Italy	+39 800985513	+39 236003759
Japan	0800.111.5011	
Netherlands	+31 8000222493	+31 207132960
New Zealand	0800.451.650	
Norway	+47 800 16836	+47 21939693
Singapore	+1.800.579.2745	
South Korea	+82 80 234 5300	
Spain	+34 911899417	+34 800300143
Sweden	+46 850619671	+46 200883979
Switzerland	+41 565800000	+41 800200442
Taiwan	00806651752	
United Kingdom	+44 8000126019	+44 2073057197
Other countries	+44.1799.534000	

Safety data sheets (SDSs)—Available on the Illumina website at support.illumina.com/sds.html.

Product documentation—Available for download from support.illumina.com.



Illumina

5200 Illumina Way

San Diego, California 92122 U.S.A.

+1.800.809.ILMN (4566)

+1.858.202.4566 (outside North America)

techsupport@illumina.com

www.illumina.com

For Research Use Only. Not for use in diagnostic procedures.

© 2019 Illumina, Inc. All rights reserved.

illumina®